



# **ALL-MC116-VDSL2**

**Point-to-Point Modem with 2 Gigabit LAN ports + SFP**

**USER'S MANUAL**

## Foreword

The ALL-MC116 is a VDSL2 CO/CPE bridge with 2 x 10/100/1000base-T LAN ports solution that's built for data transmission via 10/100/1000BASE-T Ethernet cable (UTP), line port by single twisted pair and 1.25G SFP slot. ALL-MC116 supports CO/CPE mode selectable and bands profile selectable via DIP switch on rear panel of ALL-MC116. ALL-MC116 LAN port support auto-negotiation & auto-MDIX to set up the most stable & fastest connection between ALL-MC116 and the devices that connected to it on Ethernet side.

ALL-MC116 is specifically designed for FTTdp/FTTC network, and it supports both symmetrical and asymmetrical transmission at up to 160/160Mbps and 5/1Mbps at 3000 meters, which is a perfect solution to extend LAN to buildings, hotels, hospitals or any location outside of the 10/100/1000Base-T(Ethernet) or fiber optic.

### Attention:

**Be sure to read this manual carefully before using this product. Especially Legal Disclaimer, Statement of Conditions and Safety Warnings.**

### Caution:

The **ALL-MC116** is for **indoor** applications only. This product does not have waterproof protection. Do not use in harsh environments (Over temperature range: 0°C ~ 50°C (32°F ~ 122°F)).

## Safety Warnings

For your safety, be sure to read and follow all warning notices and instructions before using the device.

- ◆ **DO NOT** open the device or unit. Opening or removing covers can expose you to dangerous high voltage points or other risks. ONLY qualified service personnel can service the device. Please contact your vendor for further information.
- ◆ **Use ONLY** the dedicated power supply for your device. Connect the power cord or power adapter to the right supply voltage (110V AC used for North America and 230V AC used for Europe).
- ◆ **DO NOT** use the device if the power supply is damaged as it might cause electrocution. If the power supply is damaged, remove it from the power outlet. DO NOT attempt to repair the power supply. Contact your local vendor to order a new power supply.
- ◆ **Place** connecting cables carefully so that no one will step on them or stumble over them. DO NOT allow anything to rest on the power cord and do not locate the product where anyone can work on the power cord.
- ◆ **DO NOT** install nor use your device during a thunderstorm. There may be a remote risk of electric shock from lightning.
- ◆ **DO NOT** expose your device to dampness, dust or corrosive liquids.
- ◆ **DO NOT** use this product near water, for example, in a wet basement or near a swimming pool.
- ◆ **Connect ONLY** suitable accessories to the device. Make sure to connect the cables to the correct ports.
- ◆ **DO NOT** obstruct the device ventilation slots, as insufficient airflow may harm your device.
- ◆ **DO NOT** place items on the device.
- ◆ **DO NOT** use the device for outdoor applications, and make sure all the connections are indoors. There may be a remote risk of electric shock from lightning.
- ◆ **Be careful** when unplugging the power, because the transformer may be very hot.
- ◆ **Keep** the device and all its parts and accessories out of children's reach.
- ◆ **Clean** the device using a soft and dry cloth rather than liquid or atomizers. Power off the equipment before cleansing it.
- ◆ This product is **recyclable**. Dispose of it properly.

## Table of Contents

<b>Safety Warnings</b> .....	<b>3</b>
1.1 Check List .....	6
<b>Chapter 2. Installing the Device</b> .....	<b>7</b>
2.1 Hardware Installation .....	7
2.2 Pre-installation Requirements.....	7
2.3 General Rules.....	8
2.4 Connecting the Ethernet of RJ-45 Ports .....	9
2.5 Connecting the SFP Slot.....	9
2.6 Connecting the Line of RJ-11 Port .....	10
2.7 Application Diagram .....	12
<b>Chapter 3. Hardware Description</b> .....	<b>13</b>
3.1 LED Indicators .....	16
ON (Steady).....	16
Line port on Link status.....	16
Blinking Fastly .....	16





Blinking Slowly.....	16
OFF .....	16
<b>Remark: 1. Except for Fiber SFP transceiver, SFP LED indicator will light up right away when the SFP transceiver insert into SFP slot.....</b>	<b>16</b>
<b>2. CO = Master / CPE =Slave.....</b>	<b>16</b>
<b>3.....</b>	<b>16</b>
<b>Appendix B: Product Specification .....</b>	<b>19</b>
<b>Appendix D: Troubleshooting .....</b>	<b>22</b>

# Chapter 1. Unpacking Information

## 1.1 Check List

Carefully unpack the package and check its contents against the check list.

### Package Contents:

			
1 x ALL-MC116	Accessory: 1 x Ethernet Cable, 4 x Rubber Feet, 1 x DC12V Adapter		

### Notes:

1. Please inform your dealer immediately for any missing or damaged parts. If possible, retain the carton including the original packing materials. Use them to repack the unit in case there is a need to return for repair.
2. If the product has any issue, please contact your local supplier.
3. Do not use sub-standard power supply. Before connecting the power supply to the device, be sure to check compliance with the specifications. The ALL-MC116 uses a DC 12V/1A power supply.
4. The power supply included in the package is commercial-grade. Do not use in industrial-grade applications.
5. Please look for the QR code on the bottom of the product, the user can launch the QR code scanning program to scan and download the user's manual electronic format file. Above QR code icon is for reference.

## Chapter 2. Installing the Device

### 2.1 Hardware Installation

This chapter describes how to install the bridge and establish the network connections. The **ALL-MC116** may be installed on any level surface (e.g. a table or shelf or rail). However, please take note of the following minimum site requirements before one begin.

### 2.2 Pre-installation Requirements

Before you start the actual hardware installation, make sure you can provide the right operating environment, including power requirements, sufficient physical space, and proximity to other network devices that are to be connected.

Verify the following installation requirements:

- Power requirements: **DC 12V / 1A or above power supply.**
- The bridge should be located in a cool dry place, with at least **10cm/4in** of space at the front and back for ventilation.
- Place **ALL-MC116** away from direct sunlight, heat sources, or areas with a high amount of electromagnetic interference.
- Check if the network cables and connectors needed for installation are available.
- Do not install phone lines strapped together with AC power lines, or telephone office line with voice signal.
- Avoid installing this device with radio amplifying station nearby or transformer station nearby.

## 2.3 General Rules

Before making any connections to the bridge, please note the following rules:

- **SFP Port**

All Fiber optical network connections to the SFP port must use Fiber 1.25G SFP transceiver.

Please note that SFP transceiver that you are using must be compatible to both side's device.

- **Ethernet Port (RJ-45)**

All network connections to the bridge Ethernet port must be made using Category 5e UTP/STP or above for 1000 Mbps, Category 5 UTP/STP for 100Mbps.

No more than 100 meters of cabling may be use between the MUX or HUB and an end node.

- **VDSL2 Port (RJ-11)**

All network connections to the RJ-11port must use **24~26** gauge with **twisted pair** phone wiring.

We **do not recommend** the use of the telephone line 28 gauge or above.

The RJ-11 connectors have six positions, two of which are wired. The device uses the center two pins. The pin out assignment for these connectors is presented below.

Please note that the line port is no polarity, therefore user can reverse the two wires of the phone cable when installed.



RJ-11 Pin out Assignments

Pin#	MNEMONIC	FUNCTION
1	NC	Unused
2	NC	Unused
<b>3</b>	<b>DSL</b>	<b>Used</b>
<b>4</b>	<b>DSL</b>	<b>Used</b>
5	NC	Unused
6	NC	Unused_

• **External Splitter installing**

- ALL-MC116 need install external splitter depend on PBX systems such as POTS/ISDN, when connecting with phone set and please make sure splitter which is compatible with local PBX system.

**2.4 Connecting the Ethernet of RJ-45 Ports**

ALL-MC116 has two Ethernet ports which support connection to Ethernet operation. The devices attached to these ports must support auto-negotiation or 10Base-T, 100Base-T or 1000Base-T unless they will always operate at half duplex. Use any of the Ethernet ports to connect to devices such as Monitor system, Server, Switch, bridge or router.

**2.5 Connecting the SFP Slot**

There are multiple types of SFP transceiver in market, please ensure the SFP transceiver is compatible to both side of device; otherwise, the connection can't set up.

## 2.6 Connecting the Line of RJ-11 Port

- ◆ The line port has 2 connectors: RJ-45 and terminal block. It is used to connect with ALL-MC116(CO) using a single pair phone cable to ALL-MC116(CPE) bridge side (point to point solution). Take note that ALL-MC116 line port RJ-11 and terminal block cannot be used at the same time. Either RJ-11 port is connected or terminal block is connected using straight connection (Figure 2.4) or cross-over connection (Figure 2.5)

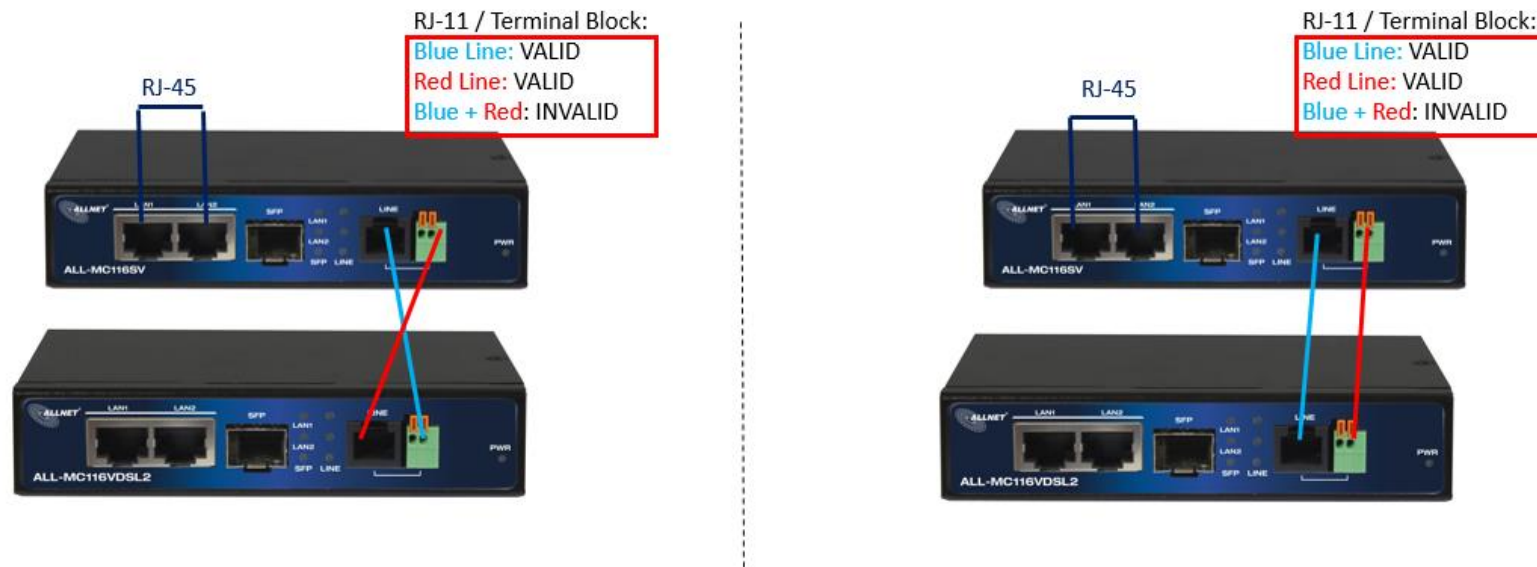

Please note that the connection between the LINE connectors have to be a twisted 2-wire cable.

- ◆ When inserting a RJ-11 plug, make sure the tab on the plug clicks into position to ensure that it is properly seated.
- ◆ **Do not** plug a RJ-11 phone jack connector into the Ethernet port (RJ-45 port). This may damage the bridge. Instead, use only twisted-pair cables with RJ-45 connectors that conform to Ethernet standard.

**Notes:**

1. Be sure each twisted-pair cable (RJ-45 Ethernet cable) does not exceed 100 meters (333 feet).
2. We advise using Category 5~7 UTP/STP cables for Cable bridge or Bridge connections to avoid any confusion or inconvenience in the future when you attached to high bandwidth devices.
3. Line port use AWG**24 ~ 26** twisted pair phone wiring, we do not recommend 28 gauge or above.
4. The Slave device (CPE) must be connected to the Master device (CO) through the telephone wire. The Slave cannot be connected to another Slave, and the Master cannot be connected to another Master. Please confirm the **DIP switch status** before the link is established.

## 2.7 Application Diagram

Even though Fiber optic is a well developed technology, it still can't reach some places due to cost & physical limit. To extend Fiber optic service to region where Fiber optic infrastructure is not advanced, ALL-MC116 will play an important role in such situation. With transmission at up to 160/160Mbps and 5/1Mbps at 3000 meters, ALL-MC116 is suitable for FTTdp/FTTC network scenario, and is a perfect solution to extend LAN to buildings, hotels, hospitals, office, etc.

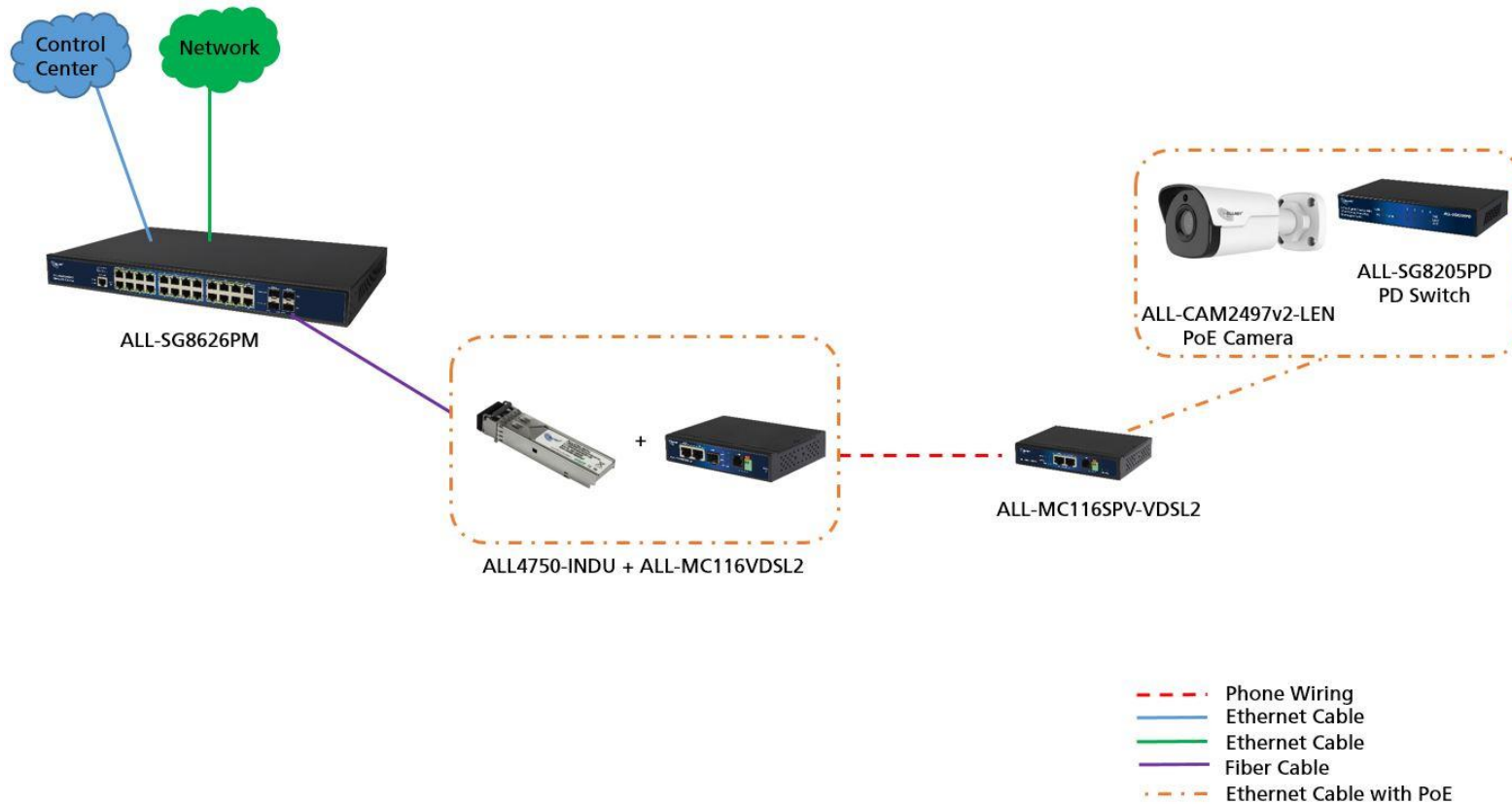

Figure 2.2 Application Diagram

## Chapter 3. Hardware Description

This section describes the important parts of ALL-MC116. It features the front panel and rear panel.

1. Front Panel: The front panel provides SFP Slot, RJ-45 Connector, RJ-11 connector and LED indicators of ALL-MC116.
- 1-1. Front panel indicator : There are 7 LEDs indicators on front panel, the following Table shows the description.



Figure 2.1 Front Panel

Tip: With only a glance of the front panel's LED indicators, the converter status will be fully aware.

**Table 2-1** Description of the front interface

Port Name	Connector type	Description
E1 / E2	RJ-45	For connecting to a Networking device.
SFP	SFP slot	For small form-factor pluggable transceiver.
LINE	RJ-11	For connecting to VDSL2 device. (Do not use RJ11 and Terminal Block at the same time.)

**Reminder: Please use SFP transceiver which is compatible to Fiber 1.25G SFP slot , otherwise, the connection cannot set up.**

1-2. Rear Panel: The rear panel provides Power DC Jack, mode-switching table and Dip Switch.



**Figure 2.2** Rear Panel

### VDSL2 bands profile Config Overview

Below table clarify the settings of 9 different VDSL modes.

DIP Switch on rear panel				Config Mode	Description
PIN1	PIN2	PIN3	PIN4		
OFF	OFF	OFF	OFF	Sy-Auto I_8/2 (SNRM 8/8)	Symmetric Auto, Max. Interleave=8, Min.Inp=2, SNRM=8 <b>(Default)</b>
OFF	ON	OFF	OFF	NSy-Auto I_8/2 (SNRM 8/8)	non symmetric Auto, Max. Interleave=8, Min.Inp=2, SNRM=8
OFF	OFF	ON	OFF	Sy-Auto I_8/2 (SNRM 6/6)	Symmetric Auto, Max. Interleave=8, Min.Inp=2, SNRM=6
OFF	ON	ON	OFF	NSy-Auto I_8/2 (SNRM 6/6)	Non symmetric Auto, Max. Interleave=8, Min.Inp=2, SNRM=6
OFF	OFF	OFF	ON	Sy-Auto G.INP_17/2/41 (SNRM 12/12)	Symmetric Auto, enable G.INP, enable re-transmission, SNRM=12
OFF	ON	OFF	ON	NSy-Auto G.INP_17/2/41 (SNRM 12/12)	non symmetric Auto, enable G.INP, enable re-transmission, SNRM=12
OFF	OFF	ON	ON	Sy-30a-D2.2M G.INP_17/2/41 (Rate 20/20) (SNRM 24/24)	Symmetric 30a, disable 0~2.2MHz, enable G.INP, enable re-transmission, Max.Line rate=20Mbps, SNRM=24
OFF	ON	ON	ON	Annex-A-17a-eu32_I-8/2 (SNRM 6/6)	17A Annex A Eu32, Max. Interleave=8, Min. Inp=2, SNRM=6
ON	NA	NA	NA	<b>CPE Mode</b>	<b><u>Switching to Slave mode</u></b>

### 3.1 LED Indicators

The ALL-MC116 has 7 LED indicators. The following Table shows the description. (Table 2-1)

**Table 2-1 LED Indicators Description and Operation**

LEDs	Color	Status	Description
PWR	Green	ON	Power Good
		OFF	Power OFF
E1/E2	Green	ON (Steady)	Ethernet port on Link status
		Blinking	Data transmission
		OFF	No Connection
CO	Green	ON	CO mode
CPE	Green	ON	CPE mode
SFP	Green	ON	SFP on Link Status
LINE	Green	ON (Steady)	Line port on Link status
		Blinking Fastly	1.Device has detected a Master / Slave device and ready to connect. 2.Data transmission
		Blinking Slowly	Device on handshaking status
		OFF	No connection

**Remark: 1. Except for Fiber SFP transceiver, SFP LED indicator will light up right away when the SFP transceiver insert into SFP slot.  
2. CO = Master / CPE =Slave**



## Appendix A: Cable Requirements

### A.1 Ethernet Cable

A CAT 5~7 UTP (unshielded twisted pair) cable is typically used to connect the Ethernet device to the Modem. A: 10/100TX cable often consists of four pairs of wires, two of which are used for transmission. The connector at the end of the 10/100TX cable is referred to as a RJ-45 connector and it consists of eight pins. The Ethernet standard uses pins 1, 2, 3 and 6 for data transmission purposes. (Table A-1 10/100TX)

B: 1000TX cable often consists of four pairs of wires, all of which are used for transmission. The connector at the end of the 1000TX cable is referred to as a RJ-45 connector and it consists of eight pins. The Ethernet standard uses pins 1, 2, 3, 4, 5 and 6 for data transmission purposes. (Table A-1 1000TX)

**Table A-1** RJ-45 Ethernet Connector Pin Assignments

PIN #	10/100TX		1000TX	
	Signal	Media Dependant interface	Signal	Media Dependant interface-cross
1	TX+	Transmit Data+	BI_DA+	Bi-directional pair A+
2	TX-	Transmit Data-	BI_DA-	Bi-directional pair A-
3	RX+	Receive Data+	BI_DB+	Bi-directional pair B+
4	NC	Unused	BI_DC+	Bi-directional pair C+
5	NC	Unused-	BI_DC-	Bi-directional pair C-
6	RX-	Receive Data-	BI_DB-	Bi-directional pair B-
7	NC	Unused	BI_DD+	Bi-directional pair D+
8	NC	Unused	BI_DD-	Bi-directional pair D-

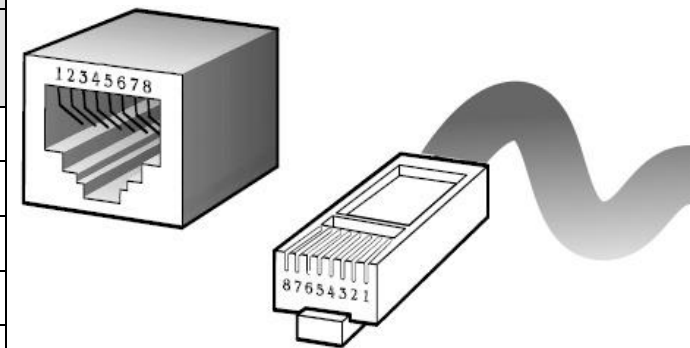

**Figure A-1** Standard RJ-45 repectacle/connector

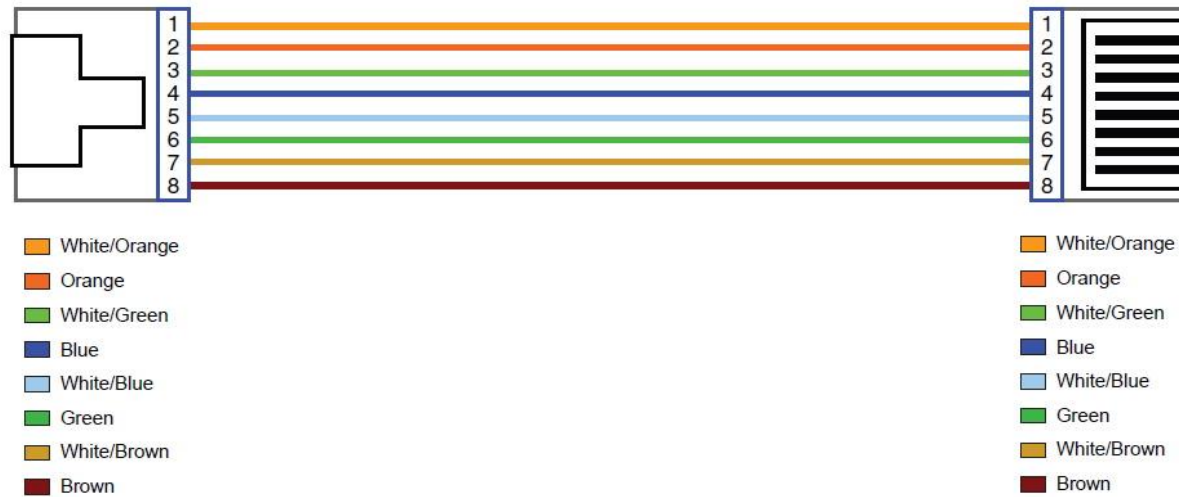

**Figure A-2 Pin Assignments and Wiring for an RJ-45 Straight-Through Cable**

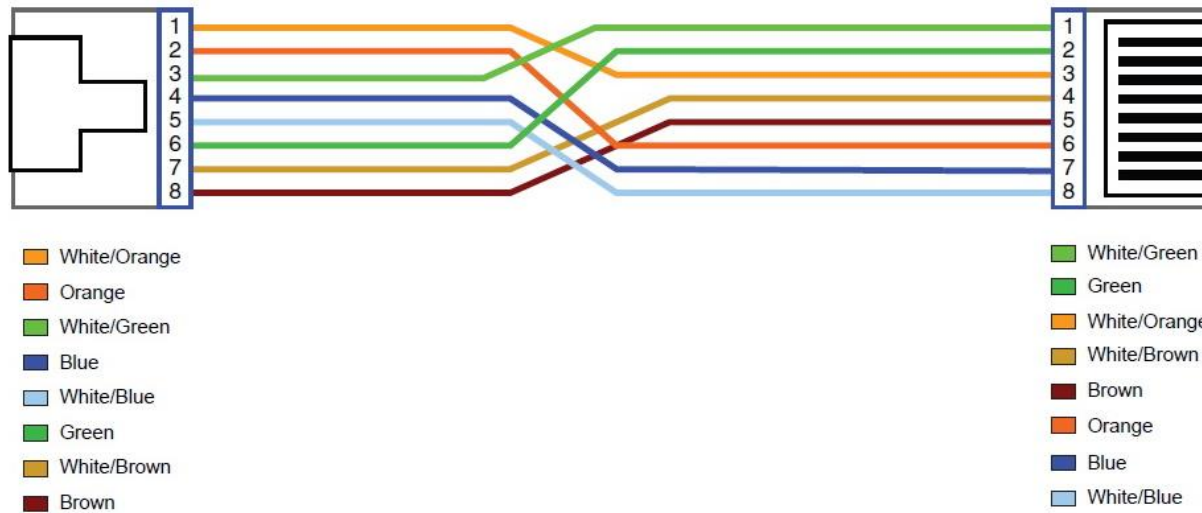

**Figure A-3 Pin Assignments and Wiring for an RJ-45 Crossover Cable**

## Appendix B: Product Specification

### Key Features and Benefits:

- ◆ Comply with IEEE802.3/802,3u/802.3ab standards
- ◆ Comply with ITU-T G.993.2 VDSL2 standard
- ◆ Supports 2 x 10/100/1000TX & auto –MDIX for RJ-45 port
- ◆ Supports 1 x 1.25G SFP Slot
- ◆ Cost effective Copper/Fiber to VDSL2 bridge function for FTTDP/FTTC application
- ◆ Up to 160/160Mbps high bandwidth
- ◆ Maximum distance up to @ 3km (9842ft)
- ◆ Selectable Master(CO) and Slave(CPE) mode via DIP switch
- ◆ Selectable G.inp mode
- ◆ Selectable 8 bands profile
- ◆ Supports UPBO & DPBO
- ◆ Supports DIN-Rail( Option ) / Wall-Mounted flexible installation
- ◆ Metal case and compact in size design
- ◆ Plug & Play
- ◆ Line port built in surge protector

## Specifications:

Item	Description
<b>Protocol and Standards :</b>	IEEE 802.3u / IEEE802.3ab / IEEE802.3z
<b>Cabling requirements:</b>	Ethernet: 1000Base-T Cat.5 or above UTP Cable Fiber Optic: 1000Base-X Flexible (Depending on Fiber Transceiver)
<b>Modes :</b>	VDSL2 CO mode X 8 + CPE mode
<b>Interface :</b>	2 x RJ-45, 1 x RJ-11, 1 x SFP slot, 1 x DIP switch, 1 x DC power jack
<b>LED Indication :</b>	PWR Link / Act Speed
<b>Certification :</b>	CE / FCC Class B, RoHS Compliant
<b>Temperature :</b>	0°C ~ 50°C (32°F ~ 122°F) (Operating ) -20°C ~ 70°C (-4°F ~ 158°F) (Storage )
<b>Optional accessories :</b>	1. Din Rail mounting plate 2. Bracket
<b>Humidity :</b>	10 - 90% (non-condensing)
<b>Weight :</b>	0.3Kg
<b>Dimensions :</b>	95mm x 110mm x 27mm (3.74" x 4.33"x 1.06' )
<b>Power Consumption :</b>	3W Typical
<b>Power Adapter :</b>	Input : AC 100~240 volts/50~60Hz Output : DC 12V/1A

## Appendix C: DIN-Rail mount installation

This appendix describes how to install the DIN-Rail to the bridged. The accessory is optional.

◆ Please refer to install the DIN-RAIL as following step:

1. Install the DIN-Rail mounting plate to the **ALL-MC116**. (Figure C-1)
2. Please use the suitable DIN-Rail to install, please refer to the dimensions of the DIN-Rail.(Figure C-2)
3. Insert the top of the DIN-Rail into the top slots on the DIN-Rail mounting plate and the DIN-Rail mounting plate will snap into place. (Figure C-3)

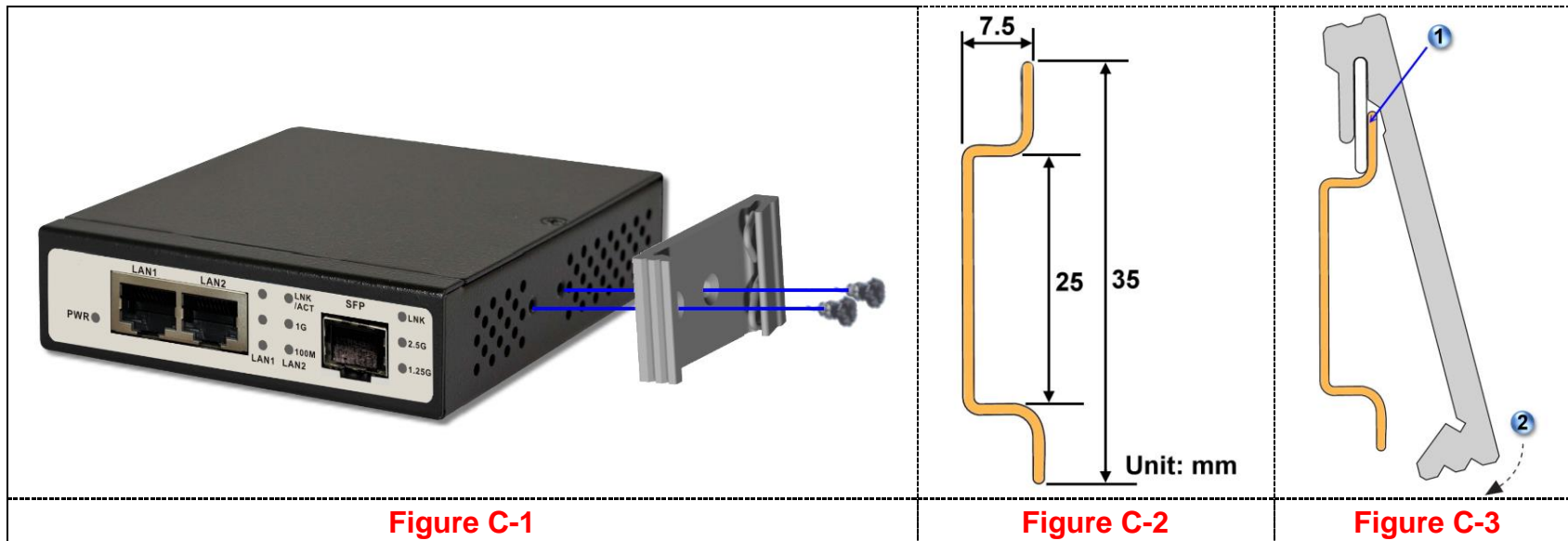

## Appendix D: Troubleshooting

### Diagnosing Bridge's Indicators

The Bridge can be easily monitored through its comprehensive panel indicators. These indicators assist in identifying problems the Media Converter may encounter. This section describes common problems you may encounter and possible solutions:

<b>1. Symptom:</b>	POWER indicator does not light up (green) after power on.
<b>Cause:</b>	Defective External power supply
<b>Solution:</b>	Check the power plug by plugging in another that is functioning properly. Check the power cord with another device. If these measures fail to resolve the problem, have the unit power supply replaced by a qualified distributor.
<b>2. Symptom:</b>	Link indicator does not light up (green) after making a connection.
<b>Cause:</b>	Network interface (ex. a network adapter card on the attached device), network cable, or switch port is defective.
<b>Solution:</b>	<ul style="list-style-type: none"><li>◆ Verify if both of the <b>ALL-MC116 (all devices)</b> and attached device are powered on.</li><li>◆ Be sure the Ethernet cable and fiber optics are plugged into both the switch and corresponding device.</li><li>◆ Verify that the proper cable type is used and its length does not exceed specified limits.</li><li>◆ Check the Adapter on the attached device and cable connections for possible defects.</li><li>◆ Replace the defective Adapter or cable if necessary.</li><li>◆ Verify CO/CPE Mode setting is correctly and repower after DIP switch setting</li></ul>

## System Diagnostics

### Power and Cooling Problems

If the POWER indicator does not turn on when the power cord is plugged in, you may have a problem with the power outlet, power cord, or internal power supply. However, if the unit power is off after running for a while, check for loose power connections, power losses or surges at the power outlet. If you still cannot isolate the problem, then the internal power supply may be defective. In this case, please contact your local dealer.

### Installation

Verify that all system components have been properly installed. If one or more components appear to be malfunctioning (e.g. the power cord or network cabling), test them in an alternate environment where you are sure that all the other components are functioning properly.

### Transmission Mode

The default of transmission mode for RJ-45 ports is 10/100/1000 Mbps Ethernet, **SFP port is 1.25Gbps (1000Base-X), and for RJ-11 port is 100Mbps xDSL**. Therefore, if the Link signal is disrupted (e.g. by unplugging the network cable and plugging it back in again, or by resetting the power), the port will try to **re-establish connection** with the attached device via auto-negotiation.

### Physical Configuration

If problems occur after altering the network configuration, restore the original connections, and try to track the problem down by implementing the new changes, one step at a time. Ensure that cable distances and other physical aspects of the installation do not exceed recommendations.

### **System Integrity**

As a last resort verify the switch integrity with a power-on reset. Turn the power to the switch off and then on several times. If the problem still persists and you have completed all the preceding diagnoses, then contact your dealer.



ALLNET GmbH Computersysteme declares that the device **ALL-MC116-VDSL2** is in compliance with the essential requirements and other relevant provisions of Directive 2014/30/EU. The Declaration of conformity can be found under this link: <http://ce.allnet.de>

ALLNET GmbH Computersysteme  
Maistrasse 2  
82110 Germering

Tel.: +49 (0)89 894 222 - 22

Fax: +49 (0)89 894 222 - 33

Email: [info@allnet.de](mailto:info@allnet.de)



CE Marking is the symbol as shown on the top of this page. The letters "CE" are the abbreviation of French phrase "Conformity European" which literally means "European Conformity". The term initially used was "EC Mark" and it was officially replaced by "CE Marking" in the Directive 93/68/EEC in 1993. "CE Marking" is now used in all EU official documents.



This symbol on the product or on its packaging indicates that this product must not be disposed of with your other household waste. Instead, it is your responsibility to dispose of your waste equipment by handing it over to a designated collection point for the recycling of waste electrical and electronic equipment. The separate collection and recycling of your waste equipment at the time of disposal will help to conserve natural resources and ensure that it is recycled in a manner that protects human health and the environment. For more information about where you can drop off your waste equipment for recycling, please contact your local city office, your household waste disposal service or the shop where you purchased the product.

This recycle logo indicates that this product is capable of being recycled, not that the product has been recycled or will be accepted in all recycling collection systems.



The RoHS directive aims to restrict certain dangerous substances commonly used in electronic and electronic equipment. This [RoHS](#)

[compliant](#) symbol indicate the component is [tested](#) for the presence of Lead (Pb), Cadmium (Cd), Mercury (Hg), Hexavalent chromium (Hex-Cr), Polybrominated biphenyls (PBB), and Polybrominated diphenyl ethers (PBDE). For Cadmium and Hexavalent chromium, there must be less than 0.01% of the substance by weight at raw homogeneous materials level. For Lead, PBB, and PBDE, there must be no more than 0.1% of the material, when calculated by weight at raw homogeneous materials. Any RoHS compliant component must have 100 ppm or less of mercury and the mercury must not have been intentionally added to the component.



## Safety Warnings

For your safety, be sure to read and follow all warning notices and instructions.

- Do not open the device. Opening or removing the device cover can expose you to dangerous high voltage points or other risks. Only qualified service personnel can service the device. Please contact your vendor for further information.
- Do not use your device during a thunderstorm. There may be a risk of electric shock brought about by lightning.
- Do not expose your device to dust or corrosive liquids.
- Do not use this product near water sources.
- Make sure to connect the cables to the correct ports.
- Do not obstruct the ventilation slots on the device.