



CE EMC TEST REPORT

For

ALLNET GmbH

Product Name:	Phase Coupler
Trademark:	ALLNET
Model :	ALL1688PC
Prepared For :	ALLNET GmbH
Address:	Maistrasse 2, 82110 Germering, Germany
Prepared By :	Shenzhen BCTC Technology Co., Ltd.
Address:	A. Floor 3, 44 Building, Tanglang Industrial Park B, Taoyuan Street, Nanshan District, Shenzhen, China
Test Date:	Dec. 14- Dec. 21, 2010
Date of Report :	Dec. 21, 2010
Report No.:	BCTC-12122613



TABLE OF CONTENT

Test Report Declaration	Page
1. GENERAL INFORMATION	6
1.1 Description of Device (EUT)	6
1.2 Test Facility	6
1.3 Tested System Details	7
1.4 Test Uncertainty.....	7
2. TEST INSTRUMENT USED	8
2.1 For Conducted Emission Test	8
2.2 For Radiated Emission Test.....	8
2.3 For Harmonic & Flicker Test	9
2.4 For Electrostatic Discharge Immunity Test	9
2.5 For RF Field Strength Susceptibility Test	9
2.6 For Electrical Fast Transient /Burst Immunity Test	10
2.7 For Surge Test	10
2.8 For Injected Currents Susceptibility Test	10
2.9 For Magnetic Field Immunity Test.....	11
2.10 For Voltage Dips Interruptions Test	11
3. POWER LINE CONDUCTED EMISSION TEST	12
3.1 Block Diagram of Test Setup	12
3.2 Test Standard	12
3.3 Power Line Conducted Emission Limit	12
3.4 EUT Configuration on Test	12
3.5 Operating Condition of EUT.....	13
3.6 Test Procedure.....	13
3.7 Test Result.....	13
4. RADIATION EMISSION TEST	14
4.1 Block Diagram of Test Setup	14
4.2 Test Standard	14
4.3 Radiation Limit	15
4.4 EUT Configuration on Test	15
4.5 Operating Condition of EUT.....	15
4.6 Test Procedure.....	15
4.7 Test Result.....	15
5. HARMONIC CURRENT EMISSION TEST	17
5.1 Block Diagram of Test Setup.....	17
5.2 Test Standard	17
5.3 Operating Condition of EUT	17
5.4 Test Procedure	17
5.5 Test Results.....	17
6. VOLTAGE FLUCTUATIONS & FLICKER TEST	18
6.1 Block Diagram of Test Setup.....	18
6.2 Test Standard	18
6.3 Operating Condition of EUT	18
6.4 Test Results.....	18
7. ELECTROSTATIC DISCHARGE IMMUNITY TEST	19
7.1 Block Diagram of Test Setup	19



7.2 Test Standard	19
7.3 Severity Levels and Performance Criterion	19
7.4 EUT Configuration.....	20
7.5 Operating Condition of EUT.....	20
7.6 Test Procedure.....	20
7.7 Test Results	21
8. RF FIELD STRENGTH SUSCEPTIBILITY TEST	23
8.1 Block Diagram of Test Setup	23
8.2 Test Standard	23
8.3 Severity Levels and Performance Criterion	24
8.4 Operating Condition of EUT.....	24
8.5 Test Procedure.....	24
8.6 Test Results	25
9. ELECTRICAL FAST TRANSIENT/BURST IMMUNITY TEST.....	27
9.1 Block Diagram of EUT Test Setup.....	27
9.2 Test Standard	27
9.3 Severity Levels and Performance Criterion	27
9.4 EUT Configuration on Test	28
9.5 Operating Condition of EUT.....	28
9.6 Test Procedure.....	28
9.7 Test Results	28
10. SURGE TEST.....	29
10.1 Block Diagram of EUT Test Setup.....	29
10.2 Test Standard	29
10.3 Severity Levels and Performance Criterion	29
10.4 EUT Configuration on Test	29
10.5 Operating Condition of EUT.....	30
10.6 Test Procedure.....	30
10.7 Test Result.....	30
11. INJECTED CURRENTS SUSCEPTIBILITY TEST	31
11.1 Block Diagram of EUT Test Setup.....	31
11.2 Test Standard	31
11.3 Severity Levels and Performance Criterion	31
11.4 EUT Configuration on Test	32
11.5 Operating Condition of EUT.....	32
11.6 Test Procedure.....	32
11.7 Test Result.....	33
12. MAGNETIC FIELD IMMUNITY TEST.....	34
12.1 Block Diagram of Test Setup	34
12.2 Test Standard	34
12.3 Severity Levels and Performance Criterion	34
12.4 EUT Configuration on Test	35
12.5 Operating Condition of EUT.....	35
12.6 Test Procedure.....	35
12.7 Test Results	35
13. VOLTAGE DIPS AND INTERRUPTIONS TEST	36
13.1 Block Diagram of EUT Test Setup.....	36
13.2 Test Standard	36
13.3 Severity Levels and Performance Criterion	36
13.4 EUT Configuration on Test	37
13.5 Operating Condition of EUT.....	37
13.6 Test Procedure.....	37



13.7 Test Result.....	37
14. EUT PHOTOGRAPHS	38
15. EUT TEST PHOTOGRAPHS	40



TEST REPORT DECLARATION

Applicant : **ALLNET GmbH**
: Maistrasse 2, 82110 Germering, Germany
Manufacture : **ALLNET China**
: D-Block 22K (22nd Floor) Huaqiang Square, Futian, Shenzhen, 518031
Guangdong, Peoples Republic of CHINA.
EUT : **Phase Coupler**
Model No : **ALL1688PC**
Rating(s) : **AC230V**

Test Procedure Used:

EMI : EN 55022 : 2010
EN 61000-3-2 :2006+A1:2009+A2:2009; EN 61000-3-3 :2008
EMS : EN 55024 : 2010
EN 61000-4-2 :2009, EN 61000-4-3 :2006+A1:2008+A2:2010,
EN 61000-4-4 :2004+A1:2010, EN 61000-4-5 :2006,
EN 61000-4-6 :2009, EN 61000-4-8 :2010, EN 61000-4-11 :2004

The device described above is tested by Shenzhen BCTC Technology Co., Ltd. to determine the maximum emission levels emanating from the device, the severe levels which the device can endure and EUT is performance criterion. The test results are contained in this test report. BCTC Testing Service Co., Ltd. is assumed of full responsibility for the accuracy and completeness of these tests. Also, this report shows that the EUT is technically compliant with the EN55022, EN61000-3-2, EN61000-3-3 and EN55024.

This report applies to above tested sample only and shall not be reproduced in part without written approval of Shenzhen BCTC Technology Co., Ltd.

Date of Test:

Dec. 14- Dec. 21, 2010

Prepared by(Engineer):

Sanji Guan

Reviewer(Quality Manager):

Sophie Lee

Approved & Authorized Signer(Manager):

Casey Wang





1. GENERAL INFORMATION

1.1 Description of Device (EUT)

EUT : **Phase Coupler**
Model Number : **ALL1688PC**
Power Supply : **AC230V**
Applicant : **ALLNET GmbH**
Address : **Maistrasse 2, 82110 Germering, Germany**

Manufacturer : **ALLNET China**
Address : **D-Block 22K (22nd Floor) Huaqiang Square, Futian, Shenzhen, 518031 Guangdong, Peoples Republic of CHINA.**
Date of report : **Dec. 21, 2010**
Date of Test : **Dec. 14- Dec. 21, 2010**

1.2 Test Facility

Site Description
Chamber : **Certificated by FCC**
&Shielded room : **Registration Number: 248337**
December 07, 2006
Certificated by VCCI
Registration Number: R-2482
February 9,
Certificated by TUV Rheinland
Registration Number: N/A
January 16, 2007
Certificated by IC
Registration Number: 117715
November 07, 2006
Certificated by Intertek
Registration Number: TMPSHA031
November 10, 2006

Name of Firm : **Shenzhen BCTC Technology Co., Ltd.**
Site Location : **A. Floor 3, 44 Building, Tanglang Industrial Park B, Taoyuan Street, Nanshan District, Shenzhen, China**



1.3 Tested System Details

Host Personal Computer	: HP	Monitor	: SONY
M/N	: A1580TW	M/N	: MNT1
Printer	: EPSON STYLUS	Keyboard (USB):	Genuine
M/N	: P320A	M/N	: N/A
Modem	: ACEEX	Mouse	: DETROIS
M/N	: DM-1414	M/N	: CM309

1.4 Test Uncertainty

Conducted Emission Uncertainty : $\pm 2.66\text{dB}$

Radiated Emission Uncertainty : $\pm 4.26\text{dB}$



2. TEST INSTRUMENT USED

2.1 For Conducted Emission Test

Conducted Emission Test (A --- site)					
Equipment	Manufacturer	MODEL#	SERIAL#	LASTCAL.	NEXT CAL.
EMI Receiver	Rohde & Schwarz	ESHS30	828985/018	Nov. 20,2010	Nov. 19,2011
LISN	Kyoritsu	KNW407	8-1789-4	Nov. 20,2010	Nov. 19,2011
Spectrum Analyzer	ADVANTENT	R3132	160400093	Nov. 20,2010	Nov. 19,2011
50Ω coaxial switch	Anritsu	MP59B	6200264417	Nov. 20,2010	Nov. 19,2011
Pulse Limiter	R&S	ESH3-Z2	100681	Nov. 20,2010	Nov. 19,2011

2.2 For Radiated Emission Test

Radiation Emission Test (966 chamber)					
Equipment	Manufacturer	MODEL#	SERIAL#	LASTCAL.	NEXT CAL.
Spectrum Analyzer	ADVANTENT	R3132	160400005	Nov. 20,2010	Nov. 19,2011
Amplifier	Tsj	MLA-10K-B01-27	1205323	Nov. 20,2010	Nov. 19,2011
Antenna	Schwarzbeck	VULB9160	9160-3206	Nov. 20,2010	Nov. 19,2011
EMI Receiver	Rohde & Schwarz	ESHS30	828985/018	Nov. 20,2010	Nov. 19,2011
Regulated Travel Charger	Schaffner	NT41	16216	Nov. 20,2010	Nov. 19,2011
50Ω coaxial switch	Anritsu	MP59B	6200264416	Nov. 20,2010	Nov. 19,2011



2.3 For Harmonic & Flicker Test

For Harmonic / Flicker Test (A --- site)					
Equipment	Manufacturer	MODEL#	SERIAL#	LASTCAL.	NEXT CAL.
Harmonic / Flicker Tester	Schaffner	CCN 1000-1	72472	Nov. 20,2010	Nov. 19,2011
Power source	Schaffner	NSG 1007-5-208-413	57227	Nov. 20,2010	Nov. 19,2011

2.4 For Electrostatic Discharge Immunity Test

For Electrostatic Discharge Immunity Test (A --- site)					
Equipment	Manufacturer	MODEL#	SERIAL#	LASTCAL.	NEXT CAL.
ESD Tester	HAEFELY	PSD 1600	H911'292	Nov. 20,2010	Nov. 19,2011

2.5 For RF Field Strength Susceptibility Test

For RF Field Strength Susceptibility Test (A --- site)					
Equipment	Manufacturer	MODEL#	SERIAL#	LASTCAL.	NEXT CAL.
Signal Generator	HP	8648A	3625U00573	Nov. 20,2010	Nov. 19,2011
Amplifier	A&R	500A100	17034	NCR	NCR
Amplifier	A&R	100W/1000M1	17028	NCR	NCR
Audio Analyzer (20Hz~1000KH z)	Panasonic	2023B	202301/428	Nov. 20,2010	Nov. 19,2011
Isotropic Field Probe	A&R	FP2000	16755	Nov. 20,2010	Nov. 19,2011
Antenna	EMCO	3108	9507-2534	NCR	NCR
Log-periodic Antenna	A&R	AT1080	16812	NCR	NCR



2.6 For Electrical Fast Transient /Burst Immunity Test

For Electrical Fast Transient/Burst Immunity Test (A --- site)					
Equipment	Manufacturer	MODEL#	SERIAL#	LASTCAL.	NEXT CAL.
Burst Tester	HAEFELY	PEFT4010	080981-16	Nov. 20,2010	Nov. 19,2011
Coupling Clamp	HAEFELY	IP-4A	147147	Nov. 20,2010	Nov. 19,2011

2.7 For Surge Test

For Surge Test (A --- site)					
Equipment	Manufacturer	MODEL#	SERIAL#	LASTCAL.	NEXT CAL.
Surge Tester	HAEFELY	PSURGE4.1	080107-04	Nov. 20,2010	Nov. 19,2011

2.8 For Injected Currents Susceptibility Test

For Injected Currents Susceptibility Test (A --- site)					
Equipment	Manufacturer	MODEL#	SERIAL#	LASTCAL.	NEXT CAL.
Simulator	EMTEST	CWS500C	0900-12	Nov. 20,2010	Nov. 19,2011
CDN	EMTEST	CDN-M2	5100100100	Nov. 20,2010	Nov. 19,2011
VDN	EMTEST	CDN-M3	0900-11	Nov. 20,2010	Nov. 19,2011
Injection Clamp	EMTEST	F-2031-23MM	368	Nov. 20,2010	Nov. 19,2011
Attenuator	EMTEST	ATT6	0010222A	Nov. 20,2010	Nov. 19,2011



2.9 For Magnetic Field Immunity Test

For Magnetic Field Immunity Test (A --- site)					
Equipment	Manufacturer	MODEL#	SERIAL#	LASTCAL.	NEXT CAL.
Magnetic field generator	Schaffner	MFO6501	34299	Nov. 20,2010	Nov. 19,2011
Magnetic field loop antenna	Schaffner	INA702	148	Nov. 20,2010	Nov. 19,2011
MC2630	EM Test	MC2630	N/A	Nov. 20,2010	Nov. 19,2011
Magnetic	Coils EM Test	MS100	0500-19	Nov. 20,2010	Nov. 19,2011

2.10 For Voltage Dips Interruptions Test

For Voltage Dips Interruptions Test (A --- site)					
Equipment	Manufacturer	MODEL#	SERIAL#	LASTCAL.	NEXT CAL.
Dips Tester	HEAFELY	PLINE 1610	083732-18	Nov. 20,2010	Nov. 19,2011

3. POWER LINE CONDUCTED EMISSION TEST

3.1 Block Diagram of Test Setup

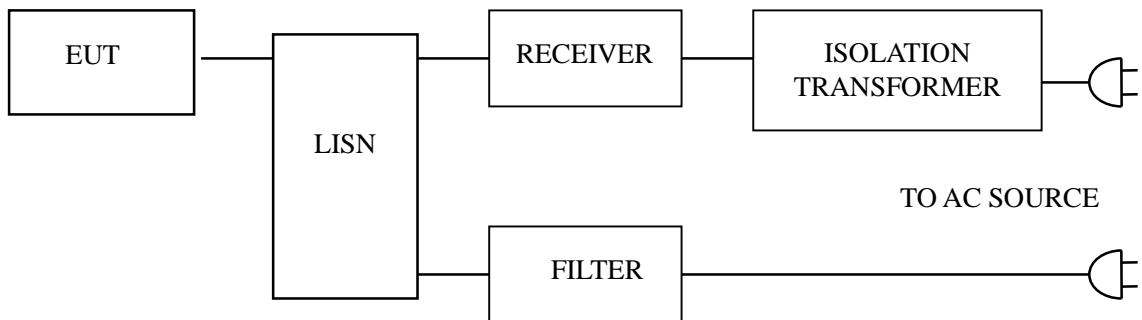

3.2 Test Standard

EN 55022 : 2010

3.3 Power Line Conducted Emission Limit

Frequency MHz	Limits dB(μV)	
	Quasi-peak Level	Average Level
0.15 ~ 0.50	66 ~ 56*	56 ~ 46*
0.50 ~ 5.00	56	46
5.00 ~ 30.00	60	50

Notes: 1. *Decreasing linearly with logarithm of frequency.

2. The lower limit shall apply at the transition frequencies.

3.4 EUT Configuration on Test

The following equipments are installed on conducted emission test to meet EN55022 requirement and operating in a manner which tends to maximize its emission characteristics in a normal application.

3.4.1 Phase Coupler(EUT)

Model Number : **ALL1688PC**

Manufacturer : **ALLNET China**



3.5 Operating Condition of EUT

- 3.5.1 Setup the EUT and simulators as shown in Section 3.1.
- 3.5.2 Turn on the power of all equipments.
- 3.5.3 Let the EUT work in test modes (On) and test it.

3.6 Test Procedure

The EUT is put on the ground and connected to the AC mains through a Artificial Mains Network (AMN). This provided a 50ohm coupling impedance for the tested equipments. Both sides of AC line are checked to find out the maximum conducted emission levels according to the **EN55022** regulations during conducted emission test.

The bandwidth of the test receiver (R&S Test Receiver ESHS30) is set at 10KHz.

The frequency range from 150 KHz to 30 MHz is investigated.

3.7 Test Result

N/A

4. RADIATION EMISSION TEST

4.1 Block Diagram of Test Setup

4.1.1. Block Diagram of EUT Test Setup

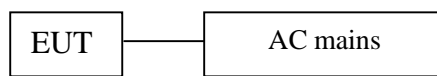

4.1.2. Anechoic Chamber Setup Diagram

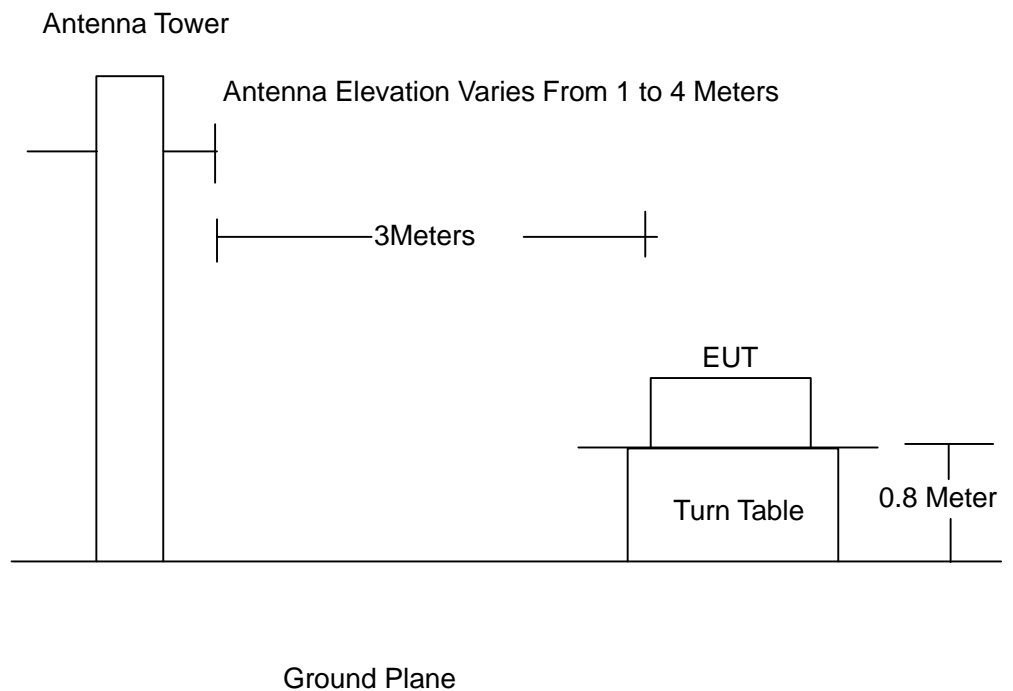

4.2 Test Standard

EN 55022 : 2010



4.3 Radiation Limit

Frequency MHz	Distance (Meters)	Field Strengths Limits dB(μ V)/m
30 ~ 230	3	40.0
230 ~ 1000	3	47.0

Remark:

- (1) Emission level (dB(μ V)/m) = 20 log Emission level (μ V/m)
- (2) The smaller limit shall apply at the cross point between two frequency bands.
- (3) Distance refers to the distance in meters between the measuring instrument, antenna and the closed point of any part of the device or system.

4.4 EUT Configuration on Test

The EN55022 regulations test method must be used to find the maximum emission during radiated emission test.

The configuration of EUT is the same as used in conducted emission test.

Please refer to Section 2.2.

4.5 Operating Condition of EUT

Same as conducted emission test, which is listed in Section 2.2 except the test set up replaced as Section 4.1.

4.6 Test Procedure

The EUT and its simulators are placed on a turned table that is 0.8 meter above the ground. The turned table can rotate 360 degrees to determine the position of the maximum emission level. The EUT is set 3 meters away from the receiving antenna that is mounted on the antenna tower. The antenna can move up and down between 1 meter and 4 meters to find out the maximum emission level. Broadband antenna (calibrated biconical and log periodical antenna) is used as receiving antenna. Both horizontal and vertical polarization of the antenna is set on test. In order to find the maximum emission levels, the interface cable must be manipulated according to EN55022 on radiated emission test.

The bandwidth setting on the field strength meter (R&S Test Receiver ESHS30) is set at 120KHz.

The frequency range from 30MHz to 1000MHz is checked.

4.7 Test Result

PASSED

Please refer to the following page.

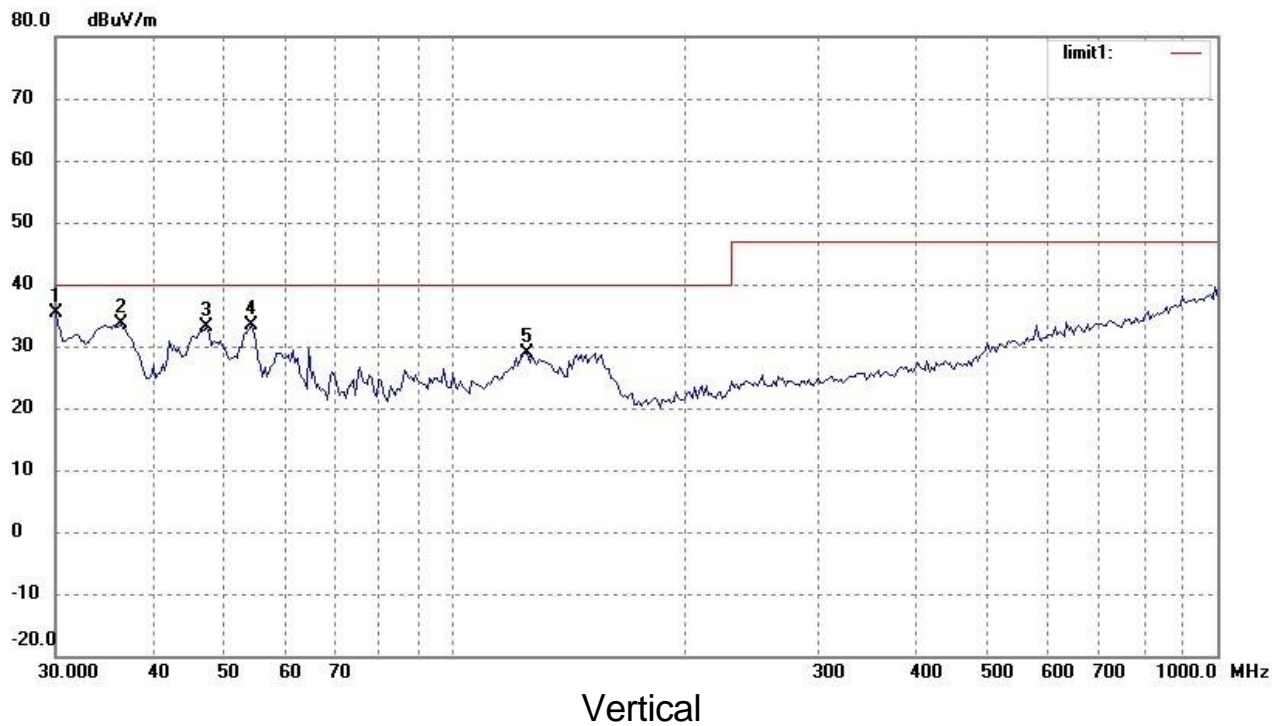
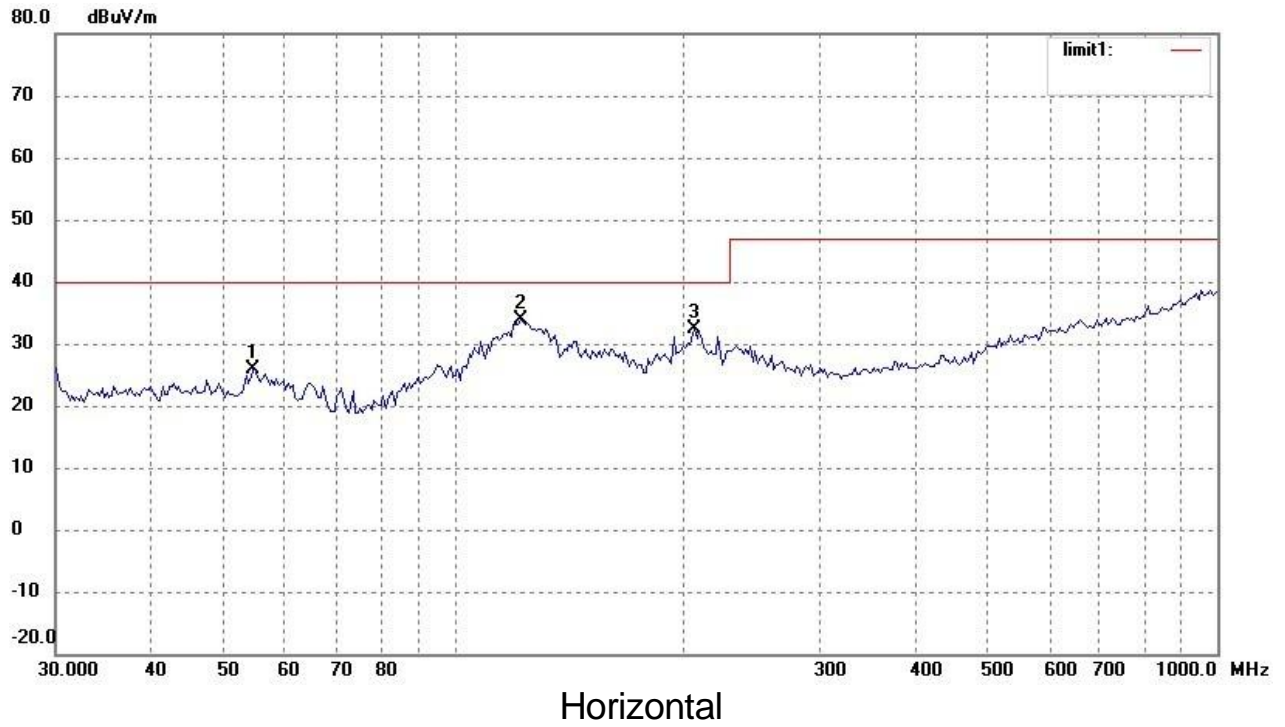

5. HARMONIC CURRENT EMISSION TEST

5.1 Block Diagram of Test Setup

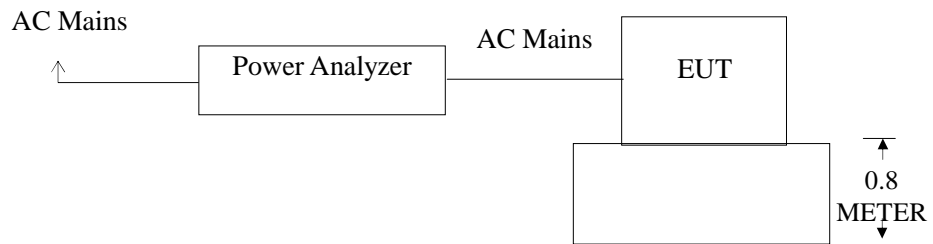

(EUT: Phase Coupler)

5.2 Test Standard

EN 61000-3-2:2006+A1:2009+A2:2009

5.3 Operating Condition of EUT

- 5.3.1 Setup the EUT as shown in Section 5.1.
- 5.3.2 Turn on the power of all equipments.
- 5.3.3 Let the EUT work in test mode (ON) and test it.

5.4 Test Procedure

The power cord of the EUT is connected to the output of the test system. Turn on the Power of the EUT and use the test system to test the harmonic current level.

5.5 Test Results

N/A



6. VOLTAGE FLUCTUATIONS & FLICKER TEST

6.1 Block Diagram of Test Setup

Same as Section 5.1..

6.2 Test Standard

EN 61000-3-3:2008

6.3 Operating Condition of EUT

Same as Section 5.3.. The power cord of the EUT is connected to the output of the test system. Turn on the power of the EUT and use the test system to test the harmonic current level.

Flicker Test Limit

Test items	Limits
Pst	1.0
dc	3.3%
dmax	4.0%
dt	Not exceed 3.3% for 500ms

6.4 Test Results

N/A

7. ELECTROSTATIC DISCHARGE IMMUNITY TEST

7.1 Block Diagram of Test Setup

7.1.1. Block Diagram of the EUT and the simulators

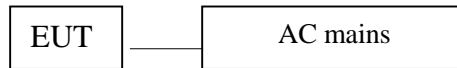

7.1.2. Test Setup

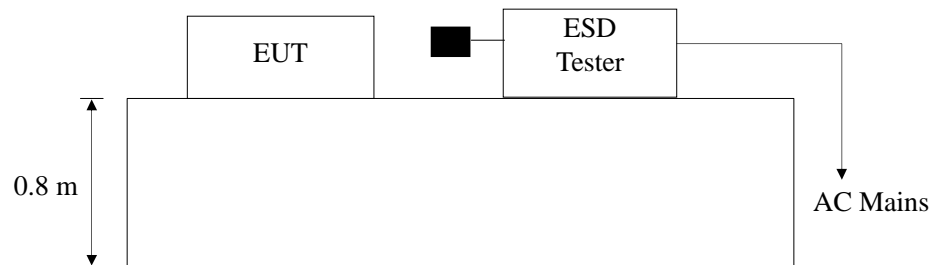

7.2 Test Standard

EN 55024:2010, EN 61000-4-2:2009

Severity Level: 3 / Air Discharge: $\pm 8\text{KV}$

Level: 2 / Contact Discharge: $\pm 4\text{KV}$

7.3 Severity Levels and Performance Criterion

7.3.1 Severity level

Level	Test Voltage Contact Discharge (KV)	Test Voltage Air Discharge (KV)
1.	± 2	± 2
2.	± 4	± 4
3.	± 6	± 8
4.	± 8	± 15
X	Special	Special

7.3.2 Performance criterion : A



- A. The apparatus shall continue to operate as intended during and after the test. No degradation of performance or loss of function is allowed below a performance level specified by the manufacturer, when the apparatus is used as intended.

- B. The apparatus shall continue to operate as intended after the test. No degradation of performance or loss of function is allowed below a performance level specified by the manufacturer, when the apparatus is used as intended. The performance level may be replaced by a permissible loss of performance. During the test, degradation of performance is however allowed.

- C. Temporary loss of function is allowed, provided the function is self-recoverable or can be restored by the operation of the controls.

7.4 EUT Configuration

The following equipments are installed on Electrostatic Discharge Immunity test to meet EN 55024:2010, EN 61000-4-2:2009, requirement and operating in a manner which tends to maximize its emission characteristics in a normal application. The configuration of EUT is the same as used in conducted emission test. Please refer to Section 2.4.

7.5 Operating Condition of EUT

Same as conducted emission measurement, which is listed in Section 3.5 except the test setup replaced by Section 7.1.2.

7.6 Test Procedure

7.6.1 Air Discharge:

This test is done on a non-conductive surface. The round discharge tip of the discharge electrode shall be approached as fast as possible to touch the EUT. After each discharge, the discharge electrode shall be removed from the EUT. The generator is then re-triggered for a new single discharge and repeated 10 times for each pre-selected test point. This procedure shall be repeated until all the air discharge completed.

7.6.2 Contact Discharge:

All the procedure shall be same as Section 7.6.1. Except that the tip of the discharge electrode shall touch the EUT before the discharge switch is operated.



7.6.3 Indirect discharge for horizontal coupling plane

At least 10 single discharges (in the most sensitive polarity) shall be applied at the front edge of each HCP opposite the center point of each unit (if applicable) of the EUT and 0.1m from the front of the EUT. The long axis of the discharge electrode shall be in the plane of the HCP and perpendicular to its front edge during the discharge.

7.6.4 Indirect discharge for vertical coupling plane

At least 10 single discharges (in the most sensitive polarity) shall be applied to the center of one vertical edge of the coupling plane. The coupling plane, of dimensions 0.5m X 0.5m, is placed parallel to, and positioned at a distance of 0.1m from the EUT. Discharges shall be applied to the coupling plane, with this plane in sufficient different positions that the four faces of the EUT are complete illuminated.

7.7 Test Results

PASSED

Please refer to the following page.



Electrostatic Discharge Test Results

Shenzhen BCTC Technology Co., Ltd.

Applicant	: ALLNET GmbH	Test Date	: Dec. 21, 2010	
EUT	: Phase Coupler	Temperature:	25°C	
M/N	: ALL1688PC	Humidity	: 53%	
Power Supply	: AC230V			
Test Engineer	: Sanji Guan			
Air Discharge: ± 8KV				
Contact Discharge: ± 4KV # For each point positive 25 times and negative 25 times discharge				
Test Points	Air Discharge	Contact Discharge	Performance Criterion	Result
Others Slot of the EUT	±2,4,8KV	N/A	A	PASSED
COVER	±2,4,8KV	N/A	A	PASSED
SCREW	N/A	±2,4 KV	A	PASSED
VCP	N/A	±2,4 KV	A	PASSED
HCP	N/A	±2,4 KV	A	PASSED

8. RF FIELD STRENGTH SUSCEPTIBILITY TEST

8.1 Block Diagram of Test Setup

8.1.1. Block Diagram of the EUT and the simulators



8.1.2. R/S Test Setup

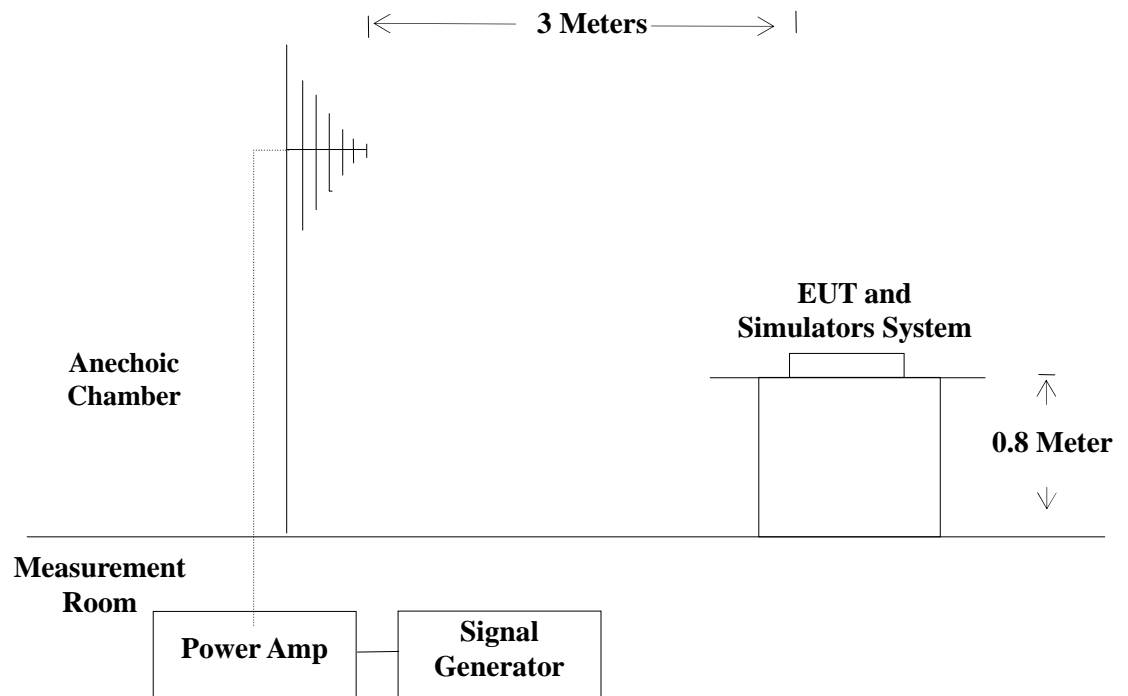

8.2 Test Standard

EN 55024:2010, EN 61000-4-3: 2006+A1:2008+A2:2010
Severity Level 2, 3V / m



8.3 Severity Levels and Performance Criterion

8.3.1. Severity level

Level	Field Strength V/m
1.	1
2.	3
3.	10
X.	Special

8.3.2. Performance criterion: A

- A、 The apparatus shall continue to operate as intended during and after the test. No degradation of performance or loss of function is allowed below a performance level specified by the manufacturer, when the apparatus is used as intended.
- B、 The apparatus shall continue to operate as intended after the test. No degradation of performance or loss of function is allowed below a performance level specified by the manufacturer, when the apparatus is used as intended. The performance level may be replaced by a permissible loss of performance. During the test, degradation of performance is however allowed.
- C、 Temporary loss of function is allowed, provided the function is self-recoverable or can be restored by the operation of the controls.

8.4 Operating Condition of EUT

Same as conducted emission measurement, which is listed in Section 2.5 except the test setup replaced by Section 8.1.

8.5 Test Procedure

The EUT and its simulators are placed on a turn table which is 0.8 meter above ground. EUT is set 3 meter away from the transmitting antenna which is mounted on an antenna tower. Both horizontal and vertical polarization of the antenna are set on test. Each of the four sides of EUT must be faced this transmitting antenna and measured individually.

All the scanning conditions are as follows :

Condition of Test	Remarks
1. Fielded Strength	3 V/m (Severity Level 2)
2. Radiated Signal	Modulated
3. Scanning Frequency	80 – 1000 MHz
4. Dwell time of radiated	0.0015 decade/s



5. Waiting Time

1 Sec.

8.6 Test Results

PASSED

Please refer to the following page.



RF Field Strength Susceptibility Test Results

Shenzhen BCTC Technology Co., Ltd.

Applicant: ALLNET GmbH		Test Date : Dec. 21, 2010	
EUT : Phase Coupler		Temperature : 25°C	
M/N : ALL1688PC		Humidity : 53%	
Field Strength: 3 V/m		Criterion: A	
Power Supply: AC230V		Frequency Range: 80 MHz to 1000 MHz	
Test Engineer: Sanji Guan			
Modulation: p AM .. Pulse .. none 1 KHz 80%			
Test Mode : On			
	Frequency Range : 80-1000MHz		
Steps	1 %		
	Horizontal	Vertical	Result
Front	A	A	Passed
Right	A	A	Passed
Rear	A	A	Passed
Left	A	A	Passed



9. ELECTRICAL FAST TRANSIENT/BURST IMMUNITY TEST

9.1 Block Diagram of EUT Test Setup

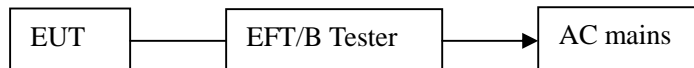

9.2 Test Standard

EN 55024:2010, EN 61000-4-4:2004+A1:2010

9.3 Severity Levels and Performance Criterion

Severity Level 2 at 1KV, Pulse Rise time & Duration: 5 nS / 50 nS

Severity Level:

Open Circuit Output Test Voltage $\pm 10\%$		
Level	On power ports	On I/O(Input/Output) Signal data and control ports
1.	0.5KV	0.25KV
2.	1KV	0.5KV
3.	2KV	1KV
4.	4KV	2KV
X.	Special	Special

Performance criterion: B

- A. The apparatus shall continue to operate as intended during and after the test. No degradation of performance or loss of function is allowed below a performance level specified by the manufacturer, when the apparatus is used as intended.
- B. The apparatus shall continue to operate as intended after the test. No degradation of performance or loss of function is allowed below a performance level specified by the manufacturer, when the apparatus is used as intended. The performance level may be replaced by a permissible loss of performance. During the test, degradation of performance is however allowed.
- C. Temporary loss of function is allowed, provided the function is self-recoverable or can be restored by the operation of the controls.



9.4 EUT Configuration on Test

The following equipments are installed on Electrical Fast Transient/Burst Immunity test to meet EN 55024:2010, EN 61000-4-4:2004+A1:2010, requirement and operating in a manner which tends to maximize its emission characteristics in a normal application. The configuration of EUT is the same as used in conducted emission test.

Please refer to Section 3.4.

9.5 Operating Condition of EUT

Same as conducted emission measurement, which is listed in Section 2.6 except the test setup replaced by Section 9.1.

9.6 Test Procedure

EUT shall be placed 0.8m high above the ground reference plane which is a min.1m*1m metallic sheet with 0.65mm minimum thickness. This reference ground plane shall project beyond the EUT by at least 0.1m on all sides and the minimum distance between EUT and all other conductive structure, except the ground plane beneath the EUT, shall be more than 0.5m

9.6.1. For input and output AC power ports:

The EUT is connected to the power mains by using a coupling device which couples the EFT interference signal to AC power lines. Both polarities of the test voltage should be applied during compliance test and the duration of the test is 2 minutes.

9.6.2. For signal lines and control lines ports:

It's unnecessary to measure.

9.6.3. For AC input and DC output power ports:

For DC ports .It's unnecessary to measure

9.7 Test Results

N/A



10. SURGE TEST

10.1 Block Diagram of EUT Test Setup

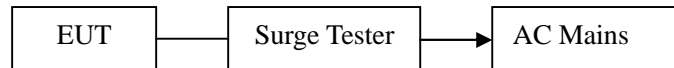

10.2 Test Standard

EN 55024:2010, EN61000-4-5:2006

10.3 Severity Levels and Performance Criterion

Severity Level: Line to Line, Level 2 at 1KV;

Severity Level: Line to Earth, Level 3 at 2KV.

Severity Level	Open-Circuit Test Voltage (KV)
1.	0.5
2.	1.0
3.	2.0
4.	4.0
X.	Special

Performance criterion: B

- A. The apparatus shall continue to operate as intended during and after the test. No degradation of performance or loss of function is allowed below a performance level specified by the manufacturer, when the apparatus is used as intended.
- B. The apparatus shall continue to operate as intended after the test. No degradation of performance or loss of function is allowed below a performance level specified by the manufacturer, when the apparatus is used as intended. The performance level may be replaced by a permissible loss of performance. During the test, degradation of performance is however allowed.
- C. Temporary loss of function is allowed, provided the function is self-recoverable or can be restored by the operation of the controls.

10.4 EUT Configuration on Test

The following equipments are installed on Electrical Fast Transient/Burst Immunity test to meet EN 55024:2010, EN61000-4-5:2006, requirement and



operating in a manner which tends to maximize its emission characteristics in a normal application

The configuration of EUT is the same as used in conducted emission test. Please refer to Section 3.4.

10.5 Operating Condition of EUT

Same as conducted emission measurement, which is listed in Section 2.7 except the test setup replaced by Section 10.1.

10.6 Test Procedure

- 1) Set up the EUT and test generator as shown on section 10.1
- 2) For line to line coupling mode, provide a 1KV 1.2/50us voltage surge (at open-circuit condition) and 8/20us current surge to EUT selected points.
- 3) At least 5 positive and 5 negative (polarity) tests with a maximum 1/min repetition rate are conducted during test.
- 4) Different phase angles are done individually.
- 5) Repeat procedure 2) to 4) except the open-circuit test voltage change from 1KV to 2KV for line to earth coupling mode test.
- 6) Record the EUT operating situation during compliance test and decide the EUT immunity criterion for above each test.

10.7 Test Result

N/A

11. INJECTED CURRENTS SUSCEPTIBILITY TEST

11.1 Block Diagram of EUT Test Setup

11.1.1. Block Diagram of EUT Test Setup



11.1.2. Block Diagram of Test Setup

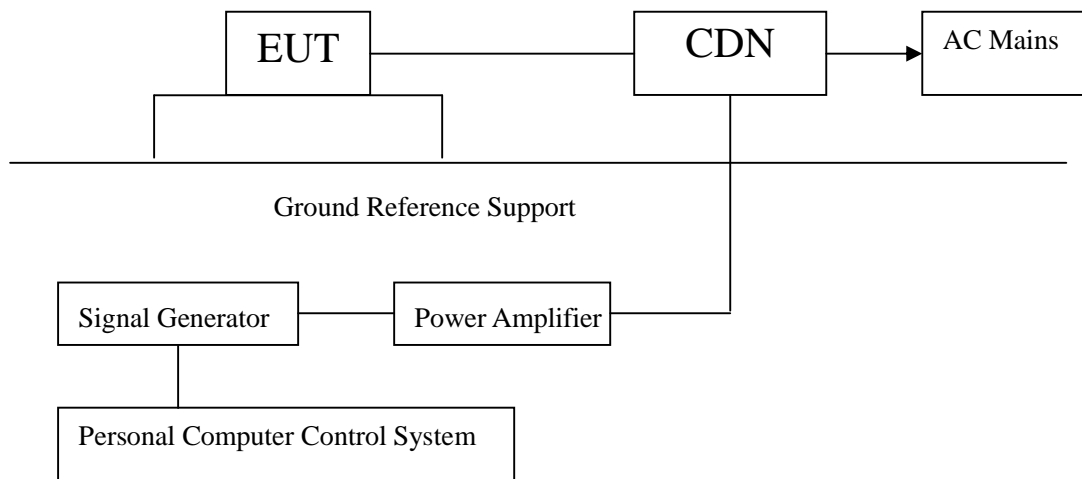

11.2 Test Standard

EN 55024:2010, EN61000-4-6:2009

11.3 Severity Levels and Performance Criterion

Severity Level 2: 3V(rms), 150KHz ~ 80MHz

Severity Level:

Level	Field Strength V
1.	1
2.	3
3.	10
X.	Special



Performance criterion: A

- A. The apparatus shall continue to operate as intended during and after the test. No degradation of performance or loss of function is allowed below a performance level specified by the manufacturer, when the apparatus is used as intended.
- B. The apparatus shall continue to operate as intended after the test. No degradation of performance or loss of function is allowed below a performance level specified by the manufacturer, when the apparatus is used as intended. The performance level may be replaced by a permissible loss of performance. During the test, degradation of performance is however allowed.
- C. Temporary loss of function is allowed, provided the function is self-recoverable or can be restored by the operation of the controls.

11.4 EUT Configuration on Test

The configuration of EUT is the same as used in conducted emission test. Please refer to Section 2.8.

11.5 Operating Condition of EUT

Same as conducted emission test, which is listed in Section 2.8 except the test set up replaced as Section 11.1.

11.6 Test Procedure

- 1) Set up the EUT, CDN and test generator as shown on section 11.1
- 2) Let EUT work in test mode and measure.
- 3) The EUT and supporting equipments are placed on an insulating support 0.1m high above a ground reference plane. CDN (coupling and decoupling device) is placed on the ground plane at above 0.1-0.3m from EUT. Cables between CDN and EUT are as short as possible, and their height above the ground reference plane shall be between 30 and 50 mm (where possible).
- 4) The disturbance signal described below is injected to EUT through CDN.
- 5) The EUT operates within its operational mode(s) under intended climatic conditions after power on.
- 6) The frequency range is swept from 150KHz to 80MHz using 3V signal level, and with the disturbance signal 80% amplitude modulated with a 1KHz sine wave



- 7) The rate of sweep shall not exceed 1.5×10^{-3} decades/s. Where the frequency is swept incrementally, the step size shall not exceed 1% of the start and thereafter 1% of the preceding frequency value.
- 8) Recording the EUT operating situation during compliance test and decide the EUT immunity criterion for above each test.

11.7 Test Result

N/A

12. MAGNETIC FIELD IMMUNITY TEST

12.1 Block Diagram of Test Setup

12.1.1 Block Diagram of the EUT

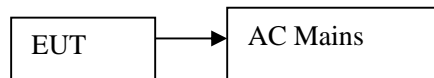

12.1.2 Block Diagram of Test Setup

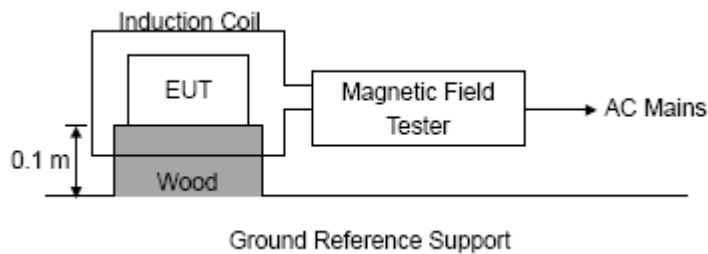

12.2 Test Standard

EN 55024:2010, EN61000-4-8:2010
Severity Level 1 at 1A/m

12.3 Severity Levels and Performance Criterion

12.3.1 Severity level

Level	Magnetic Field Strength A/m
1.	1
2.	3
3.	10
4.	30
5.	100
X.	Special



12.3.2 Performance criterion: B

- A. The apparatus shall continue to operate as intended during and after the test. No degradation of performance or loss of function is allowed below a performance level specified by the manufacturer, when the apparatus is used as intended.
- B. The apparatus shall continue to operate as intended after the test. No degradation of performance or loss of function is allowed below a performance level specified by the manufacturer, when the apparatus is used as intended. The performance level may be replaced by a permissible loss of performance. During the test, degradation of performance is however allowed.
- C. Temporary loss of function is allowed, provided the function is self-recoverable or can be restored by the operation of the controls.

12.4 EUT Configuration on Test

The configuration of EUT is listed in Section 2.9.

12.5 Operating Condition of EUT

Same as conducted emission test, which is listed in Section 2.9 except the test set up replaced as Section 12.1.

12.6 Test Procedure

The EUT shall be subjected to the test magnetic field by using the induction coil of standard dimensions (1m*1m) and shown in Section 10.1. The induction coil shall then be rotated by 90° in order to expose the EUT to the test field with different orientations.

12.7 Test Results

N/A



13. VOLTAGE DIPS AND INTERRUPTIONS TEST

13.1 Block Diagram of EUT Test Setup

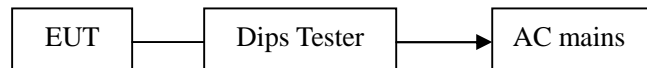

13.2 Test Standard

EN 55024:2010, EN61000-4-11:2004

13.3 Severity Levels and Performance Criterion

Severity Level:

Input and Output AC Power Ports.

p Voltage Dips.

p Voltage Interruptions.

Environmental Phenomena	Test Specification	Units	Performance Criterion
Voltage Dips	>95 0.5	% Reduction period	B
	30 25	% Reduction period	C
Voltage Interruptions	>95 250	% Reduction period	C

Performance criterion: B, C, C

- A. The apparatus shall continue to operate as intended during and after the test. No degradation of performance or loss of function is allowed below a performance level specified by the manufacturer, when the apparatus is used as intended.
- B. The apparatus shall continue to operate as intended after the test. No degradation of performance or loss of function is allowed below a performance level specified by the manufacturer, when the apparatus is used



as intended. The performance level may be replaced by a permissible loss of performance. During the test, degradation of performance is however allowed.

- C. Temporary loss of function is allowed, provided the function is self-recoverable or can be restored by the operation of the controls.

13.4 EUT Configuration on Test

The configuration of EUT is the same as used in conducted emission test. Please refer to Section 2.10.

13.5 Operating Condition of EUT

Same as conducted emission test, which is listed in Section 2.10 except the test set up replaced as Section 13.1.

13.6 Test Procedure

- 1) Set up the EUT and test generator as shown on section 13.1
- 2) The interruption is introduced at selected phase angles with specified duration. There is a 3mins minimum interval between each test event.
- 3) After each test a full functional check is performed before the next test.
- 4) Repeat procedures 2 & 3 for voltage dips, only the level and duration is changed.
- 5) Record any degradation of performance.

13.7 Test Result

N/A

14. EUT PHOTOGRAPHS

EUT Photo 1

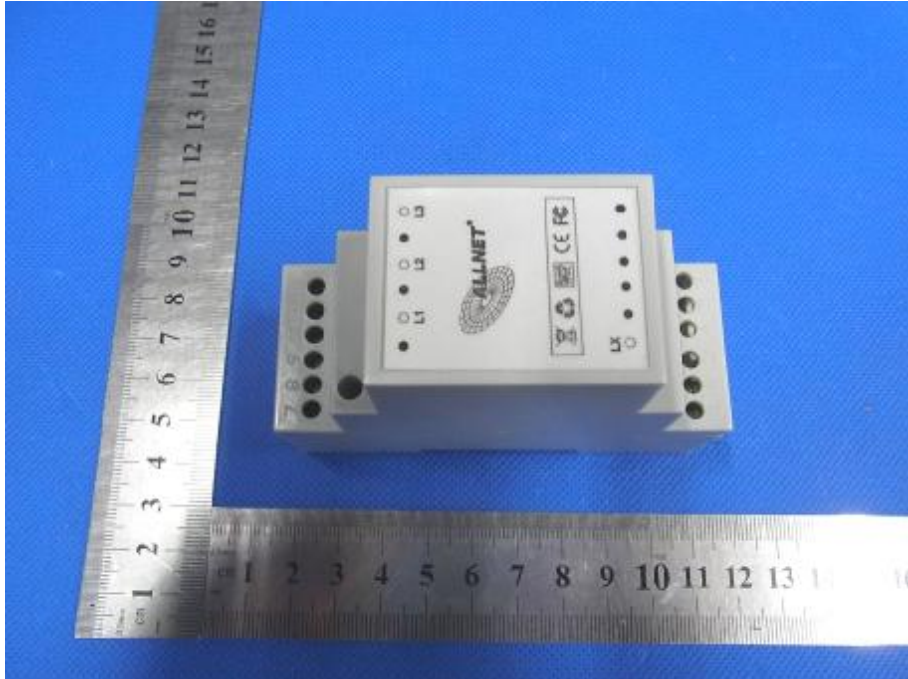

EUT Photo 2



EUT Photo 3

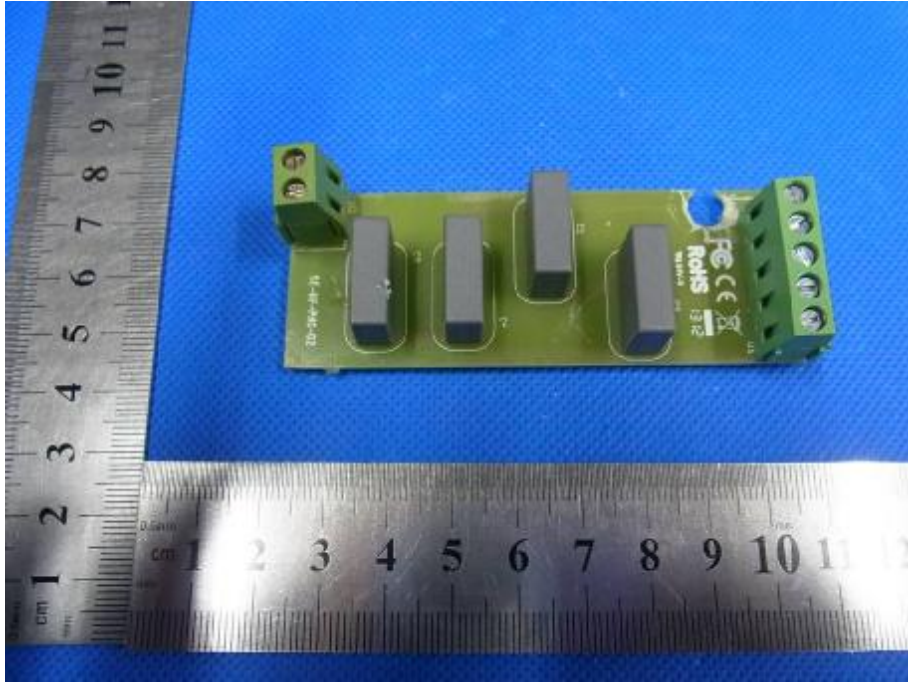

EUT Photo 4

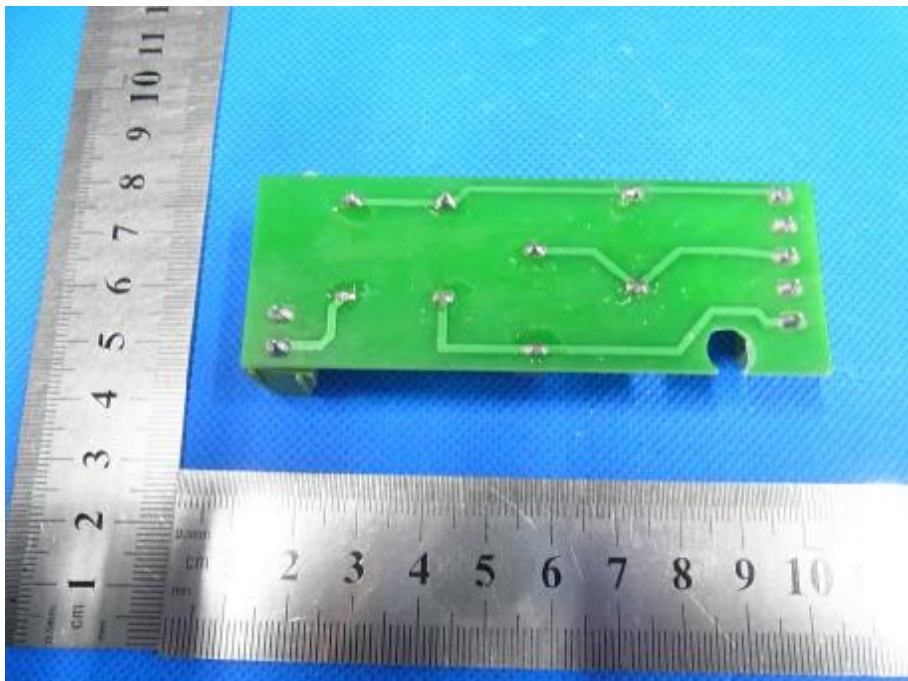

15. EUT TEST PHOTOGRAPHS



***** END OF REPORT *****