

NOTE:

1. Electrical test:

- (1).100% open short & miss wire test;
- (2).Insulation resistance:DC 200V 10M ohm min
- (3).Contactor resistance:3 ohm max;

(4).Displayport practical application Test 1080P Pass

2. PACKING:1PCS/SYNERGY21 BAG+LABEL1, 10/5PCS/PE BAG+LABEL2

3. ROHS2.0 AND REACH COMPLIANT

4. PRINT WORD:E350755 兄 AWM 20276 80°C 30V VW-1 DVI DIGITAL DUAL LINK

PIN OUT

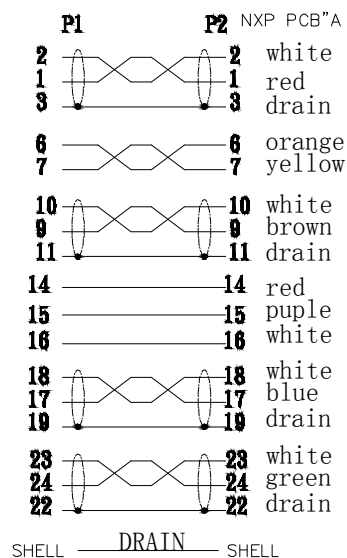

⑩	DUST CAP	DP 20/M TRANSPARENT PE	1	
⑨	DUST CAP	DVI24+1 TRANSPARENT PE	1	
⑧	THUMB SCREW	B-L30.5 MOLD BLACK PVC, SCRWE PLATED NICKEL	2	
⑦	CONNECTOR	DVI (24+1)/M SOLDER, BLACK INSULATION, THE PIN GOLD PLATED , THE SHELL FOR GOLD PLATED	1	
⑥	OUT MOLD	BLACK PVC	1	
⑤	TUBE END	BLACK PVC	1	
④	INNER MOLD	LDPE	2	
③	OUTER COVER	BLACK ABS ASSEMALY	1	
②	CONNECTOR	DP 20P/M LATCHING, SOLDER TYPE, BLACK INSULATION, WHIE PCB' A(IC PIN3361B) THE PIN GOLD PLATED , THE SHELL FOR GOLD PLATED	1	
①	CABEL	(30AWG TC*1P+D+AM)*4+30AWG TC*3C+30AWG TC*1P+AM+D+ B+PVC/BLACK 6.0+/-0.2MM	1	

ITEM NO	LENGTH	BAG
S215430	1000 ± 30	A
S215429	1500 ± 30	A
S215431	2000 ± 50	A
S215432	3000 ± 50	B
S215433	5000 ± 70	B

SYNERGY 21

NO.	PARTS NAME	SPECIFICATION DESCRIPTION	QT'Y	REMARK	CUSTOMER	ITEM NO.	see the cahrt
		UPDATE PACKING TYPE AND ADD TIEM NO. :S215429	2018-03-27	A1	PRODUCT NAME	DisplayPort 20P/M-DVI (24+1)/M	MANUFACTURE COUNTRY: CHINA
		NEW	2014.09.24	A	DRAWNBY	CHECKBY	APPOBY
BY	CHK	REVISION RECORD MODIFICATIONS	DATE	REV.	SYNERGY 21	SYNERGY 21	SYNERGY 21
							UNIT MM
							DATE
							2018-03-27

Labeling sample:

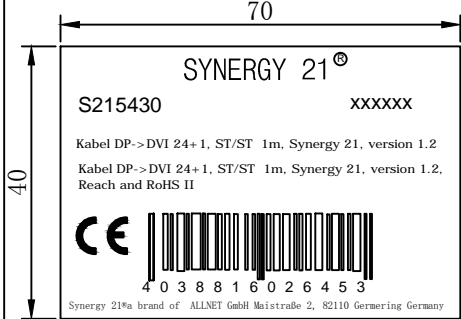

Label 1

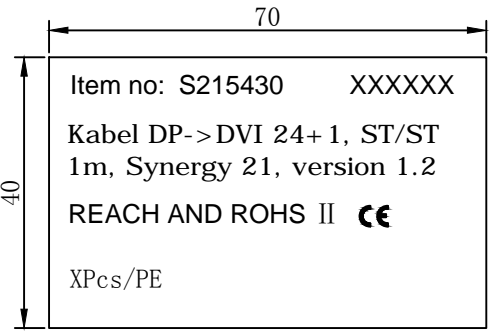

Label 2

Five layer corrugated carton(outer carton):

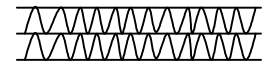

three layer corrugated carton(inner carton):

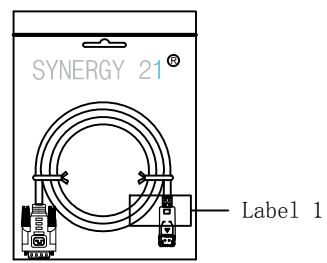
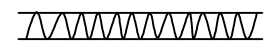

1PCS/SYNERGY BAG

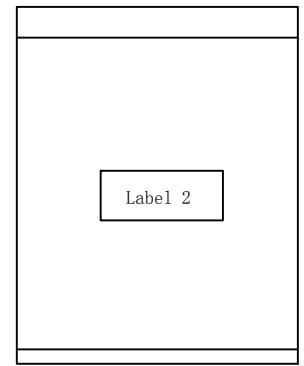
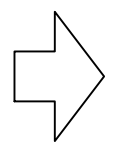

10/5PCS/PE BAG

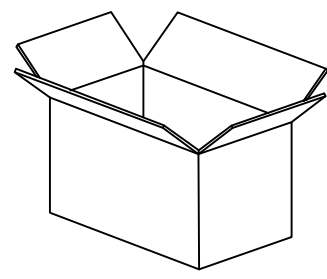
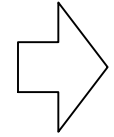

inner carton

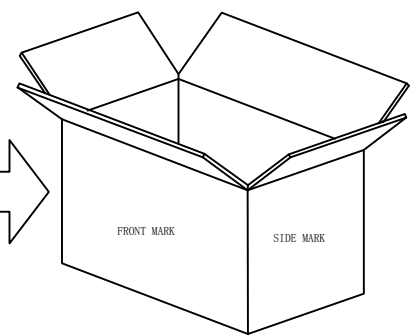
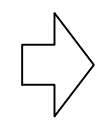

Outer carton

“工” Sealing

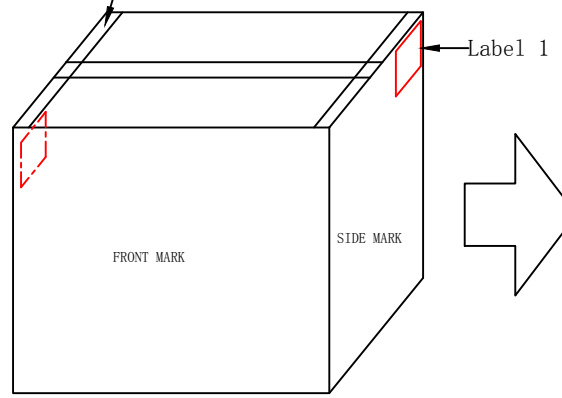

Outer carton

“井” Packaging

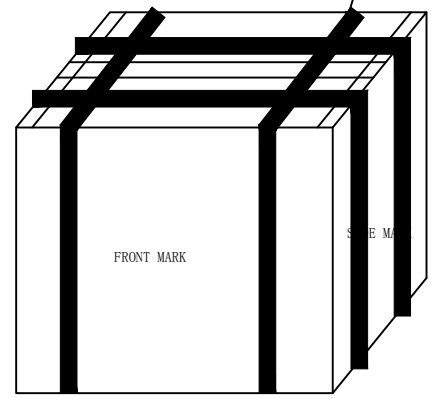

Outer carton

master mark



PO NO. :
REACH and ROHS 2.0 Compliant
MADE IN CHINA

side mark

PO NO. :
Item no:
Q' TY:
N. W
G. W
Carton no.
MEAS.

SYNERGY 21

		UPDATE PACKING TYPE AND ADD TIEM NO. :S215429	2018-03-27	A1	CUSTOMER		ITEM NO.	see the chart		
		NEW	2014. 09. 24	A	PRODUCT NAME	PACKING	MANUFACTURE COUNTRY:	CHINA	UNIT	MM
BY	CHK	REVISION RECORD MODIFICATIONS	DATE	REV.	SYNERGY 21	SYNERGY 21	APPOBY	SYNERGY 21	DATE	2018-03-27