

9W deep anti-glare LED CCT downlight

Model No. : FUT076ZR

Product Feature

- ZIGBEE3.0 standard protocol
- Deep plastic enclosure with best anti-glare performance, UGR≤19
- Dimmable color temperature from 2700-6500K
- 2.4G wireless transmission technology
- smooth dimming with 4096 level, mini brightness 0.1%
- Signal auto transmitting extend distance of communication
- Have DND function, usually used in power failure area and save power
- Support TUYA SMART app control (2.4G gateway is needed)
- Support third party voice control like Alexa, Google assistant, Yandex Alice, Tmall Genie, Baidu and Xiaomi



Product Parameter

Product Name: :	9W deep anti-glare LED CCT downlight	IP rate:	IP20
Model No.:	FUT076ZR	Working Temperature:	-10~40°C
Input voltage:	AC100~240V 50/60Hz	Hole Size:	60mm
Power:	9W	Dimming Level:	4096
Power factor:	>0.5	Dimming Range:	0.1~100%
CRI:	>90	Dimming Curve:	logarithm
Color temperature:	2700~6500K	EMC Standard (EMC):	ETSI EN 301 489-1 V2.2.3 ETSI EN 301 489-3 V2.3.2
Luminous Flux:	700LM	Security Standard (LVD):	ET IEC 60598-1:2021+A11:2022 EN 60598-2-2: 2012 EN IEC 62031:2020+A11:2021 EN 62498:2015+A1:2022
Luminous efficiency:	78LM/W	Radio equipment (RED):	ETSI EN 300 400 V2.2.1
Beam Angle:	24°	Certification	CE, EMC, LVD, RED
Protocol:	Zigbee 3.0 + 2.4GHz RF		
Control Distance:	Zigbee: 50M(open area)/ 2.4G RF: 30M		

Dimension

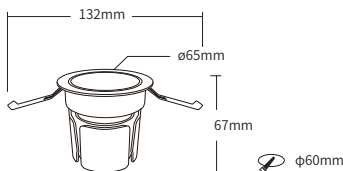

Installation Tips

Please read instruction before installing it, you can contact with our service center if there is any technical issue

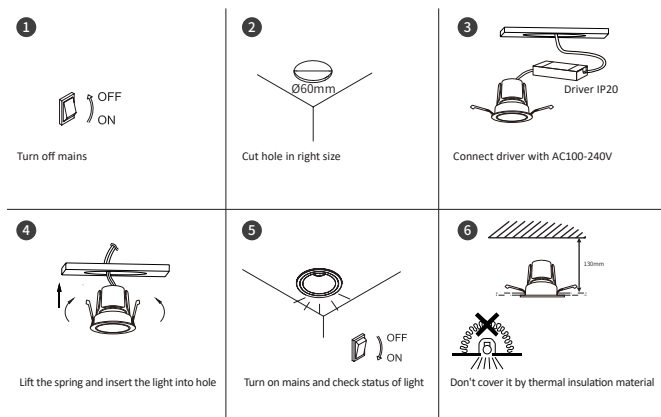

Lighting source can not be replaced, please buy new light if the light is over lifetime

Auto transmitting

signal auto transmitting

The light receive signal from remote and auto transmitting to another lights within 30m, it can extend unlimited distance

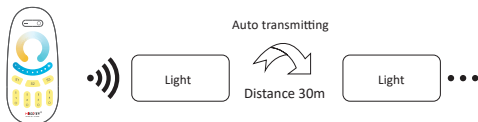

Link/Unlink

Link controller must link with remote before using it

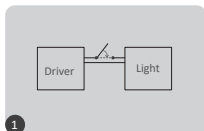

turn off light 10 seconds and turn on again



short press " | " 3 times within 3 seconds

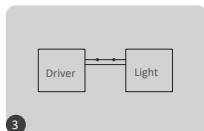

link is done once light flashes 3 times slowly



Link is failed if light doesn't flash, please repeat above steps
(Attention: can not link again if remote already finished linking)

Unlink:

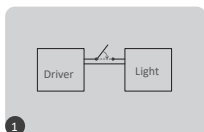

turn off light 10 seconds and turn on again

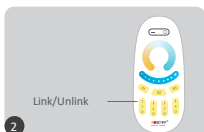

short press " | " 5 times within 3 seconds

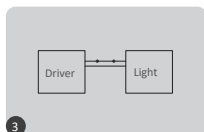

link is done once light flashes 10 times quickly



Unlink is failed if light doesn't flash, please repeat above steps
(Attention: no need to unlink if the light never be linked)

Compatible Remote (purchase separately)



FUT094



FUT006



FUT007



FUT087/FUT087-B



B1/ B1-B/ T1



B2/ T2



K1/ K1-B



K2/ K2-B



K3



C1



C3



Y2

DND mode ON/OFF (factory default is ON)

Turn ON DND:

Short press "OFF" 3 times within 3 seconds and short press "ON" 3 times, DND mode is activated if the light flashes 4 times quickly

Attention: The status of light (ON or OFF) is same as turn on or off mains

Turn off DND

Short press "ON" 3 times within 3 seconds and short press "OFF" 3 times, DND mode is shut down if the light flashes 4 times slowly

Attention: The light is always ON if turn on or off mains

APP Instruction

It must connect with Zigbee 3.0 gateway and add gateway into "TUYA SMART"APP (please check gateway instruction)

- 1.Connect with mains
- 2.Enter into network pairing mode (**factory default is network pairing mode**)
Solution: Turn ON and Turn OFF light 3 or over 3 times continuously, the light status is breathing
- 3.Go to "TUYA SMART" APP main page and click gateway, click" Add subdevice"
- 4.Click " indicator is flashing quickly"
- 5.Dimming or group control... etc after adding successfully

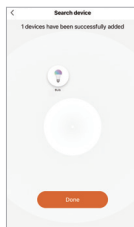
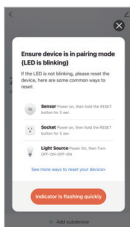
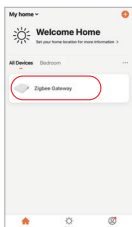

Turn ON or OFF DND (factory default is ON)

Click the light or the group - click " more " - Click "Power-on behavior"

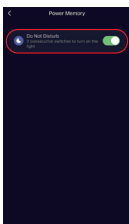
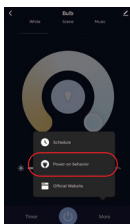
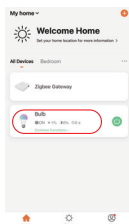

Philips Hue Instruction

It must connect with Philips Hue and add device into "Philips Hue" APP

- 1.Connect with mains
 - 2.Enter into network pairing mode (factory default is pairing mode)
- Solution: turn off and turn on light 3 or over 3 times continuously, the light is breathing
- 3.Enter into "Philips Hue"APP main page and click "SETTINGS", click "Lights"
 - 4.Click "+"
 - 5.Click " Search"
 - 6.Searching device for a while and click "Start configuration", finish the steps

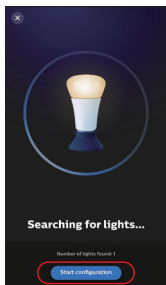
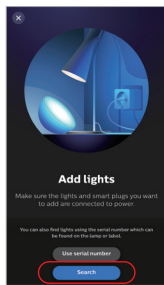
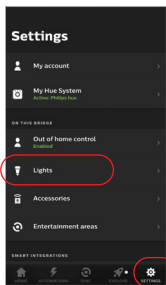

Alexa voice control instruction

1. Alexa control (Audio conform to zigbee 3.0 protocol)

Amazon Echo can connect with device directly, the following model already conformed to zigbee 3.0 protocol)

Amazon ECHO Plus (2nd Gen), ECHO (4th Gen), ECHO Studio, ECHO Show (2. Gen)

1). Connect with mains

2. Enter into network pairing mode (factory default is pairing mode)

Solution: turn off and turn on light 3 or over 3 times continuously, the light is breathing

3. Speak to Amazon Echo " Alexa, Discover devices",

search device for a while and control via your voice command directly

"Alexa, Discover devices"



2). Alexa control (audio is not built in zigbee 3.0 protocol)

Please add device into Miboxer zigbee 3.0 gateway firstly

1). Enter into Alexa APP

2). Click "More"

3). Click "Skills& Games"

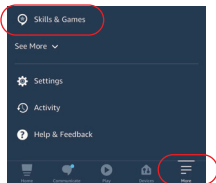

4). Click " Q "

5). Type into "smart life" and search



6). Click "smart life" skills and finish the steps

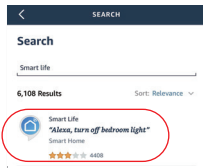

Google Home voice control

Please add device into Miboxer zigbee 3.0 gateway

1) . Enter into Google Home APP

2) . Click "+"

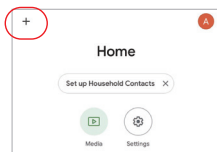

3) . Click "Set up device"

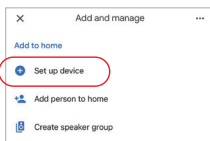

4) . Click "works with Google"

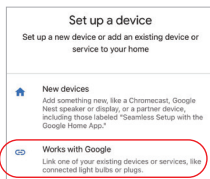

5) . Click " Q "

6) . Type into "Smart life" and search

7) . Click "smart life" skills and finish the steps

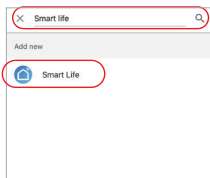

Connection Diagram

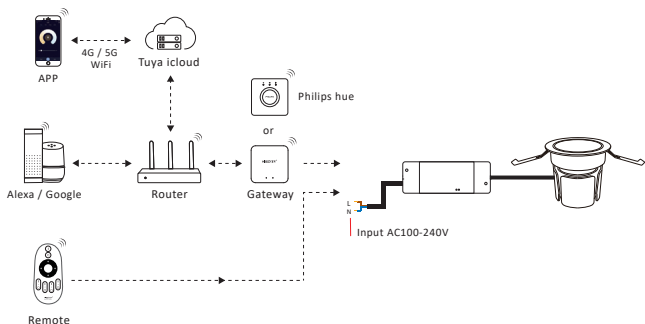

Attention

1. Please ensure that voltage, N and L are correct connection, it will damage the light with wrong wiring
2. Please turn off mains before wiring cable and ensure that connection don't have any problem like short circuit
3. Don't disassemble it if you are not expert
4. Don't use it near magnetic or metal area, it will affect signal and reduce distance.



Made in China