



No. d'article: 207522
Numéro de fabricant: ANT-868-6dbi-OMNI

ALLNET Antenn8 868MHz 6dbi Antenne (N-Female) Omni LoRa



EAN CODE

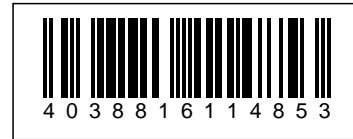

Highlights:

- 860~880MHz omnidirectional antenna, 3 array
- Gain: 6dbi (see data sheet for more details)
- Beam angle: H360 V26
- Impedance: 50 Ohm
- VSWR: ≤ 1.3 @868MHz, Max 1.5
- Connector: N-Type Female (suitable connection cables can be found in the accessories)
- Dimension: Length = 800mm x Diameter 20mm
- Max. Windload: 180km/h
- Temperature: $-40^{\circ}\text{C} \sim +60^{\circ}\text{C}$
- Mounting: Wall mounting & Mast mounting
- Package contents: Antenna and accessories
- Ideal for LoRA / Helium Network / Helium Miner / IoT terminals / 868MHz systems etc.

Technical Details:

Model	ANT-868-3dbi-OMNI	ANT-868-5dbi-OMNI, 2 Array	ANT-868-6dbi-OMNI, 3 Array	ANT-868-7.3dbi-OMNI, 7 Array
Electrical Specification	Frequency : 868MHz, 860-880MHz			
Polarization	Vertical Polarized			
Max Gain	3.5dbi	5dbi	6dbi	7.3dbi
H Beamwidth	360deg / omni coverage			



No. d'article: 207522
Numéro de fabricant: ANT-868-6dbi-OMNI

E Beamwidth	65deg	32deg	26deg	20deg
VSWR	typical: <1.3 @868MHz, Max 1.5			
Nominal Impedance	50 ohm			
Max Power	50watts			
Mechanical Specification				
Connector	N-Female, Long Neck			
Radome	Fiberglass, Dia 20mm			
Color	White/Grey			
Total Length with Connector	314mm	600mm	800mm	1000mm
Weight incl Mount Kit	0.55kg	0.65kg	0.7kg	0.8kg
Working Temperature Range	-45°C to +75°C			
Max winload	180km/h			
Storage Temperature	-50°C to +75°C			

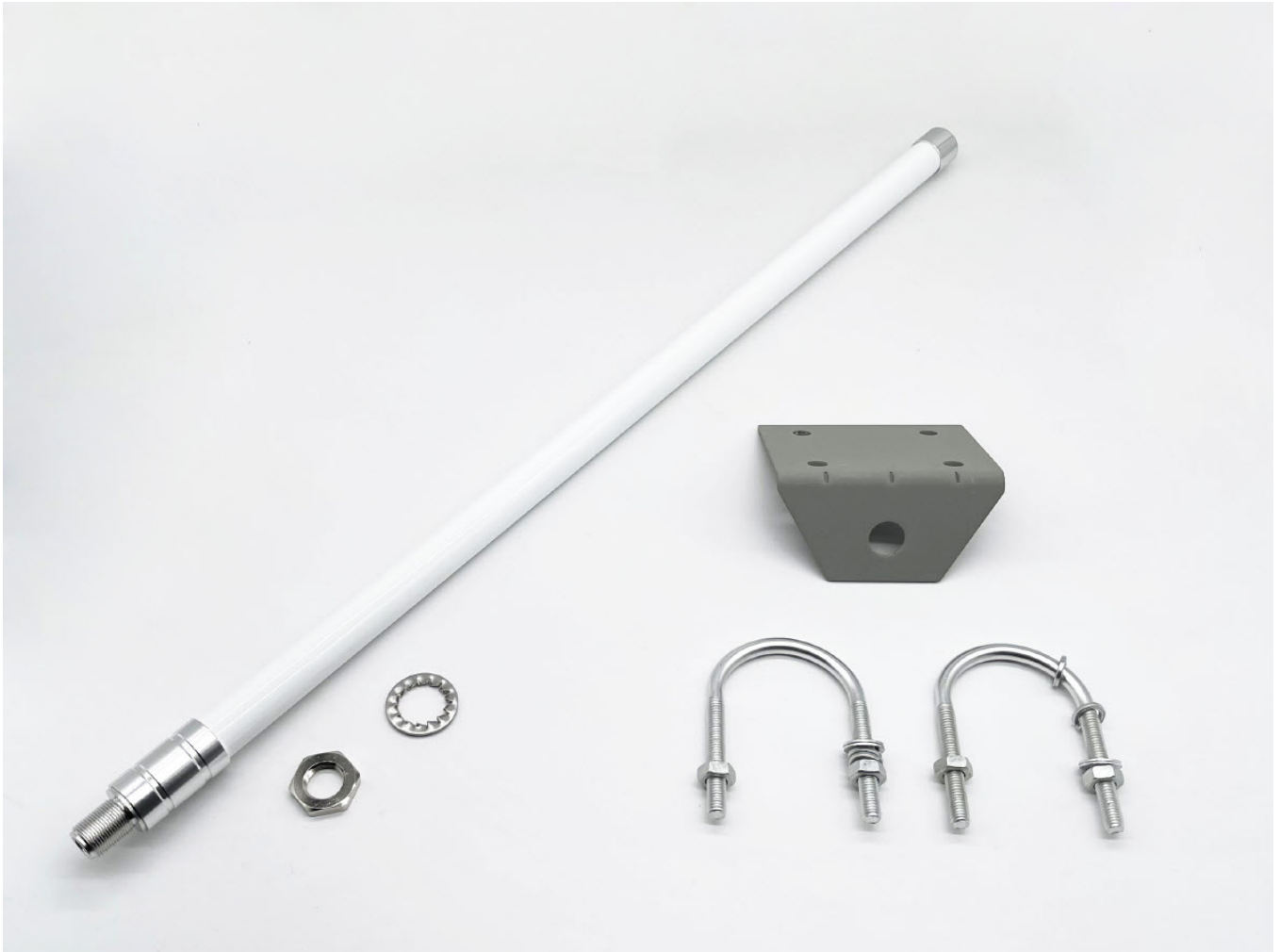

Antenna Test Data:

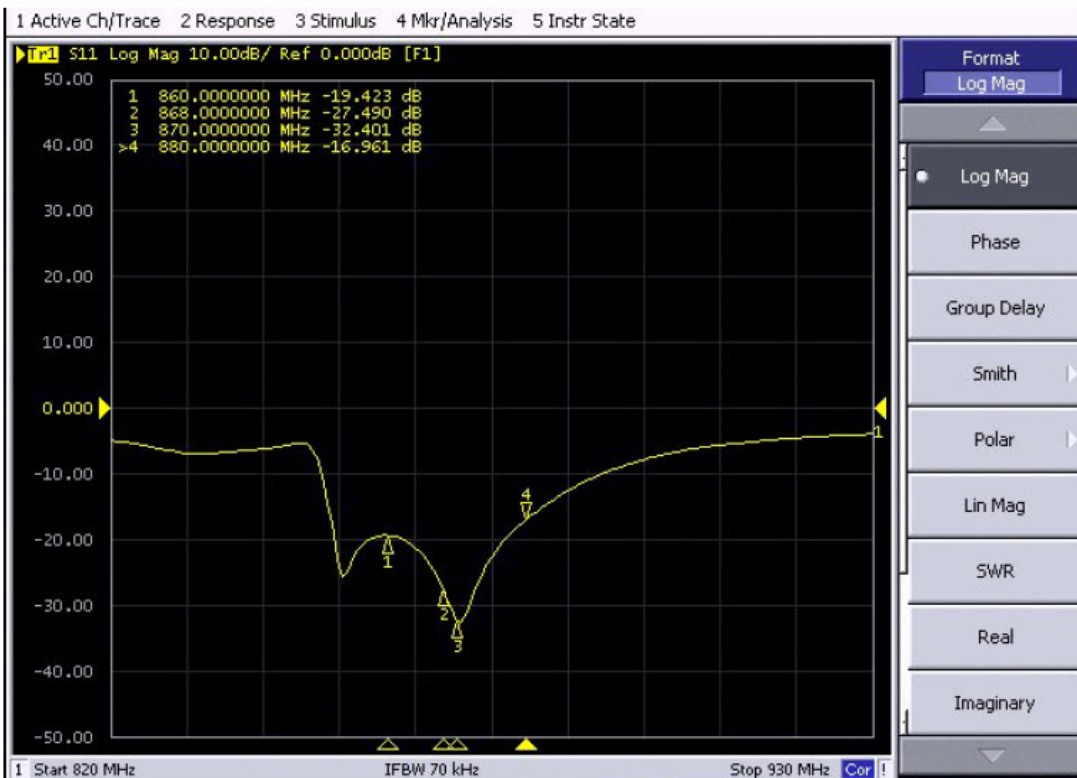
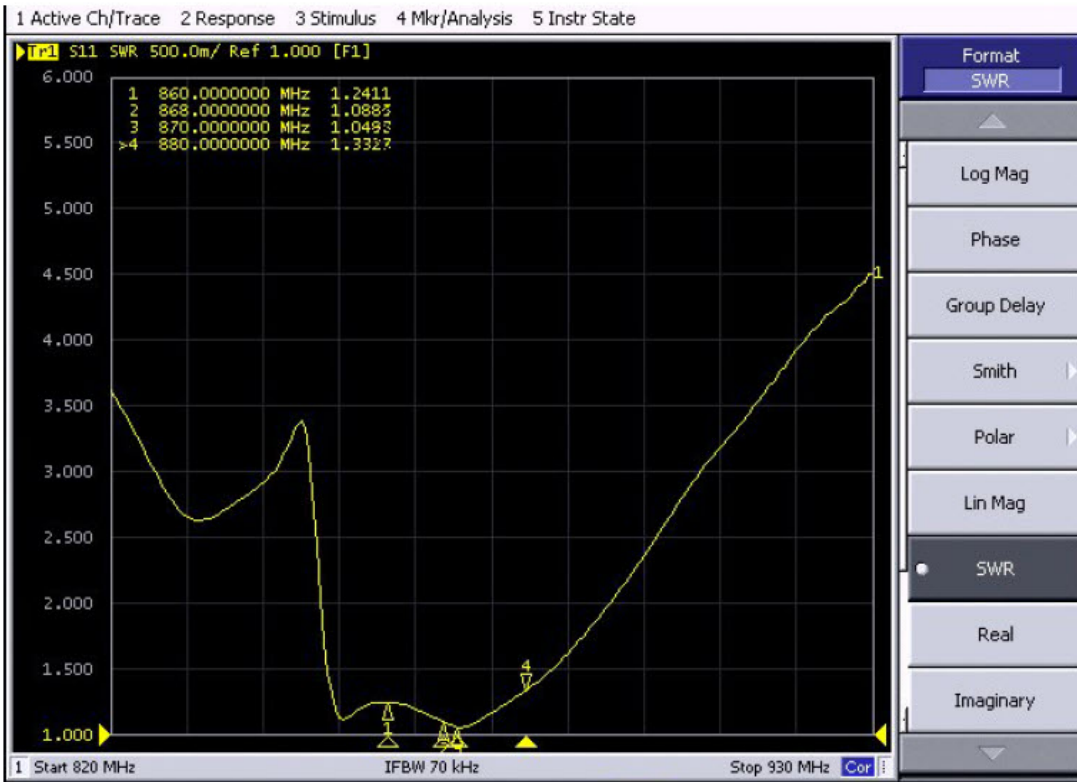

2D Radio Pattern:

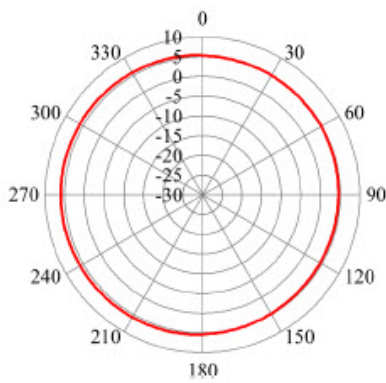

— 868MHz Horizontal

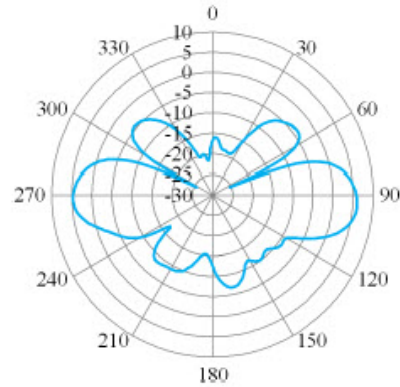

— 868MHz Vertical

3D Radio Pattern:

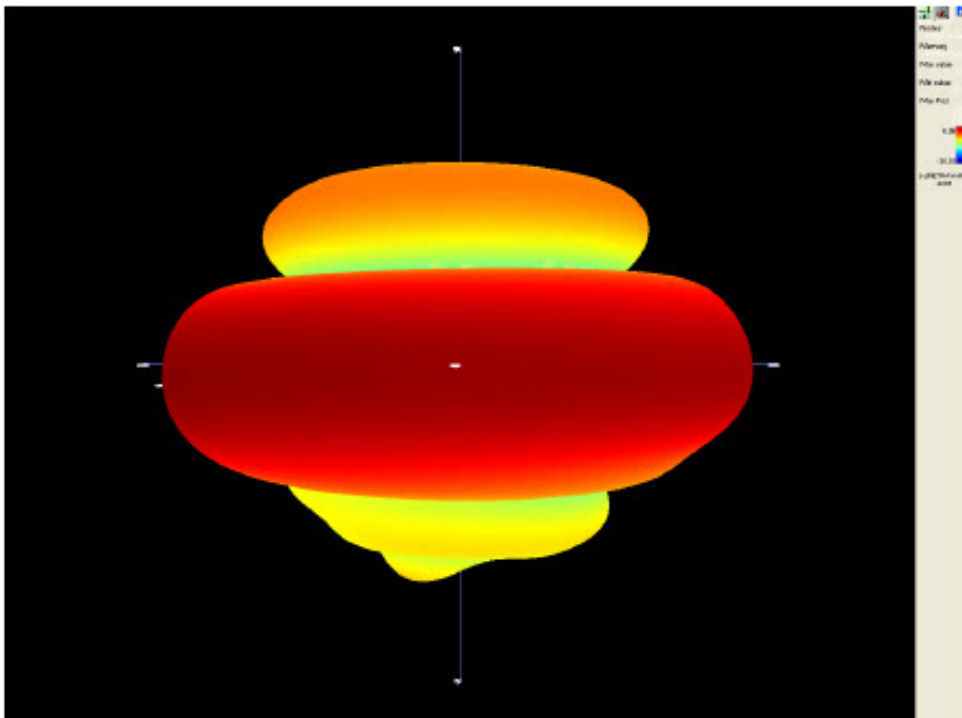

Installation:



No. d'article: 207522
Numéro de fabricant: ANT-868-6dbi-OMNI

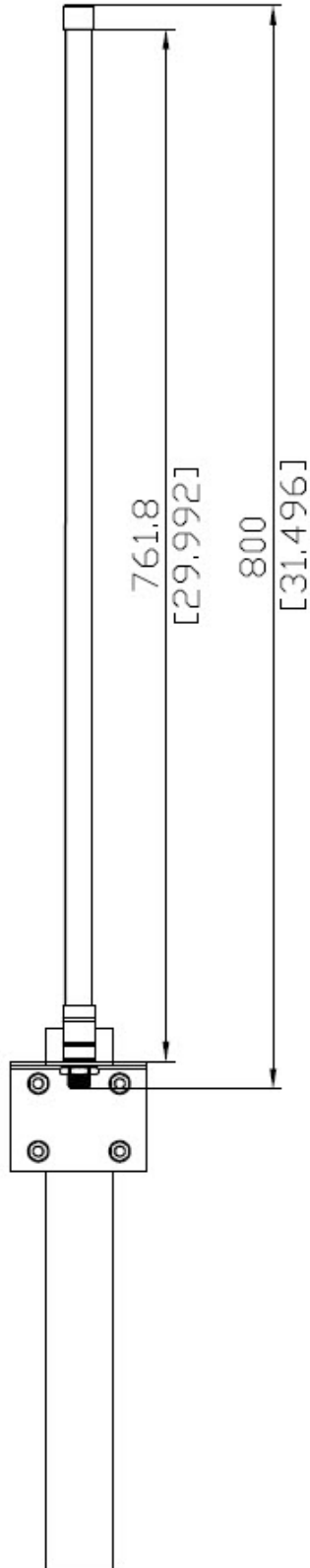

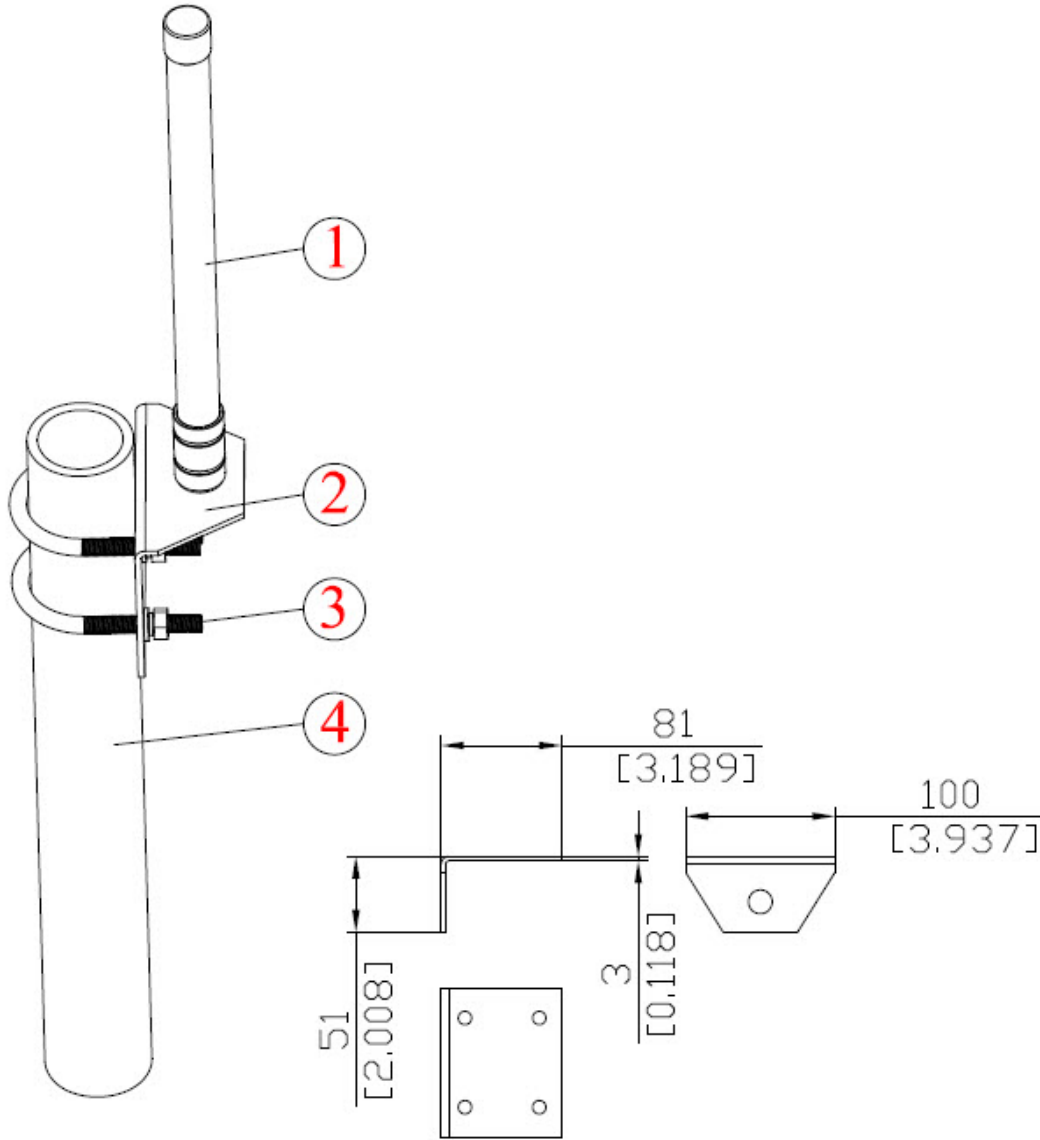

Pole Installation

- 1.. ANTENNA
2. L-shape Mount Kit
3. U Bolts
5. POLE

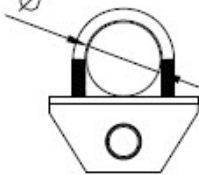

1. Mount kits for Pole
 Dia: $\varnothing 30$ – $\varnothing 50$

Images supplémentaires

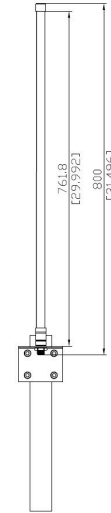

Accessoires

No. d'article	Désignation
177056	ALLNET Antennen-Kabel LMR-195 R-SMA(m) <> N-Type(m) 1000 cm
88874	ALLNET Antennenkabel LMR-195 R-SMA - N-Type 1,5 Meter
88875	ALLNET Antennenkabel LMR-195 R-SMA - N-Type 3,0 Meter
88876	ALLNET Antennenkabel LMR-195 R-SMA - N-Type 5,0 Meter
88877	ALLNET Antennenkabel LMR-195 R-SMA - N-Type 7,0 Meter